

GRIMTOOTH'S TRAPS TOO

A game-master's aid for
all role-playing systems



WARNING:
The Chiurgeon Royal has
determined that Grimtooth's
Traps can be hazardous to
your characters' health!

55 from JEFF DEE

**101 MORE TRAPS
FOR USE WITH ANY
ROLE-PLAYING SYSTEM**



All-System



**Catalyst
Series**

#B502

Grimtooth's

TRAPS TOO

**a game-master's aid for
all role-playing systems**

*A convenient catalog of condemnable calamities,
ghastly glammers, distinctive disasters, and
irreverent inconveniences, as well as an astonishing array
of annoying misdirections and miserable misfortunes
to spring on passing adventurers, explorers,
tunnelers, delvers, and all manner of player characters...*

in other words, The Troll is Back!

edited by

Paul Ryan O'Connor

Pat Mueller

Michael Stackpole

front cover by

Jeff Dee & Crompton

illustrated by

Steven S. Crompton

OK, HERE'S
MY **BACK**. THAT'S
ALL YER' SEEN' OF
ME ON **THIS**
PAGE.





Flying Buffalo Inc.

ATTENTION:

The traps in this book are designed for game purposes only. Actual construction of these traps might prove harmful, and such construction is strongly discouraged. Events depicted in this book are imaginary, and should not be attempted by a real person.

Copyright © 1982 Flying Buffalo Inc
New Material Copyright © 2006 Flying Buffalo Inc
All Rights Reserved

No part of this book may be reproduced or transmitted in any form or by any means, electronic or mechanical, including photocopying, recording or computerization, or by any information storage and retrieval system, without permission in writing from the publisher, Flying Buffalo Inc, PO Box 8467, Scottsdale, AZ 85252 USA

This book contains all the material from the Original Grimtooth's Traps Too, plus 9 pages of descriptions of how to use these traps in the "Fudge" system, plus 7 pages of a new Grimtooth Comic. Your comments and suggestions are welcome, especially about whether or not you'd like to see more Grimtooth Comics or more Grimtooth Puzzles, or both. Email your comments to me at rick@flyingbuffalo.com or postally mail them to the above address.

Rick Loomis

Visit our web page at: WWW.FLYINGBUFFALO.COM

DEAD-ICATION

To those who have passed through these traps
before And to those who followed behind to
pick up the pieces.

—GT

**A man named the Marquis de Sade
Had habits exceedingly odd.
When Grimtooth he met,
He broke out in a sweat,
For the troll was much crueler, by God!**

— The Magic Rat

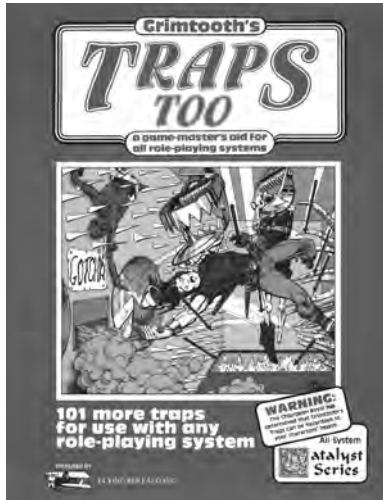

Original cover to Traps Too - 1982



A Word From Grimtooth

This volume really speaks for itself. Each trap is fully explained, without going into the specifics of game mechanics, and should be easy to understand. Each trap also has a Deadliness Rating, defined in skulls, located near it – the more skulls you see, the more deadly the trap is.

So why am I writing this? Because a few of you numbskulls out there still haven't caught on to what it means to be a Game Master. A GM doesn't slavishly follow *anything* – books, manuals, or edicts from On High – except his own bloodshot instincts. For the true Game Master, any reference work such as this can only be a guideline.

But a few of you haven't learned this.

Some of you wrote to me and said that you thought my traps were too deadly.
TOO DEADLY????!!!?

What's going on here? How can a trap be *too* deadly? Most of these traps, having been designed by mere mortals, *aren't* deadly enough.

All right, I'll accept the fact that some of you out there have twisted ideas about how to administrate a dungeon. Newfangled ideas about delvers escaping with their lives, and stuff like that. To each his own, I suppose. But if you're going to be a maverick, then you've got to blaze your own trails. Don't ask me to make my traps less deadly . . . change them yourself.

Now isn't that a fresh idea? Bet you can't find a rule for that in your hardbacks.

You see, these traps are now *yours* – you don't need special permission or a membership card to change them to your liking. Use your imagination. Use these traps any way you want to. I won't come after you if you do. But if I ever receive another letter about how my traps are too deadly, I'm going to hand some wimp his head. Is that clear, human worms? Grimtooth will not be bothered again!

And now, on to my book – the greatest tome ever written about Traps.

– Grimtooth

P.S. If you're wondering whatever happened to my editor, Paul O'Connor, or his traditional editorial, then you should know that he, too, felt that some of my traps were a little rough. Well, who needs him, anyway? Too big for his britches, I say, to sneak that page of his into my last book. Well, I've sent Paul into an exile from which he won't soon return!

Grim



THIS PAGE
INTENTIONALLY
LEFT BLANK

NOT ANY
MORE!



Room traps are regimented death boxes about which the wheel of fantasy gaming rotates. They are not to be dealt with lightly, for they fold, spindle, and mutilate dungeon delvers with more panache and malice than any other form of trap.

Room traps tend toward the bizarre. Rare indeed is the subtle room trap – these things prefer to scream their presence to even the most dense of delvers, abandoning all surprise in favor of snaring the curious cat. Most room traps are content to remain unsprung, but you know there will always be at least one stooge in the party who wants to investigate. . . .

In this chapter you'll find bridges, spiders, giant gas bags, and malevolent book presses plus a horde of other unlikely delver dooms . . . the stuff of legends. . . .

Room Traps

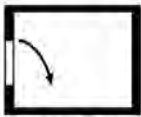

I always prefer to begin my collections with an outrageous trap based more in fantasy than reality. Thus, to open this chapter of my second book of traps, I boldly present the eminently logical **Beware of Low Ceiling** trap by Jason Sato, a Game Master of warped perceptions.

This trap is located in a large natural cavern with a high ceiling. A deep chasm divides the cavern. There is only one way to traverse the chasm — a handy suspension bridge has been provided for this purpose. The bridge appears to be in

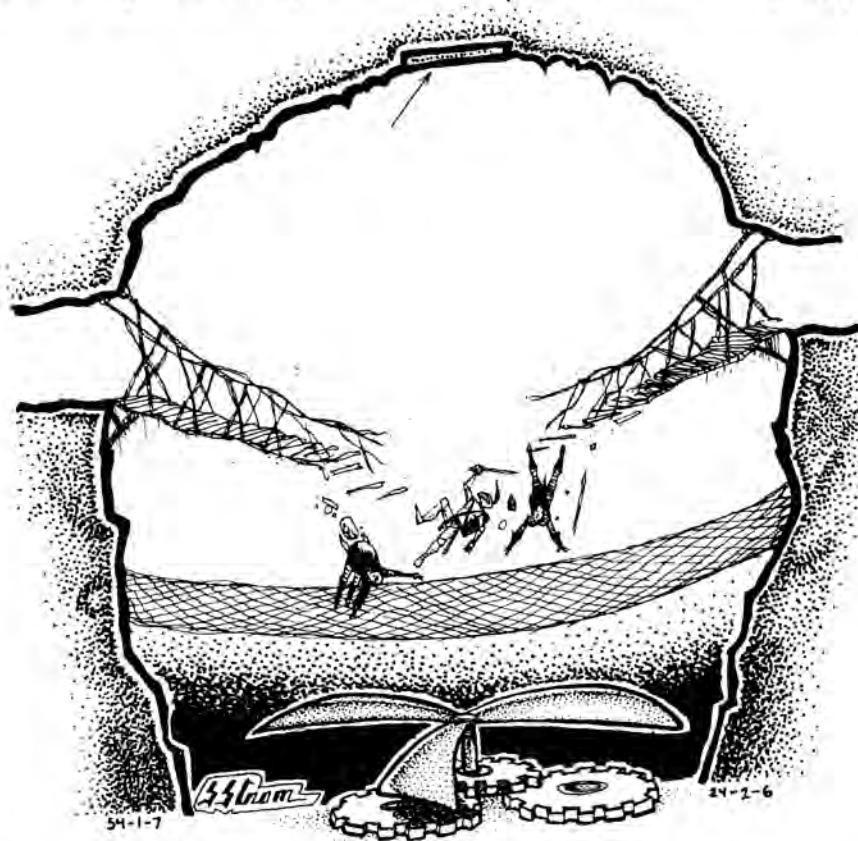

good shape; it feels sturdy although it sways a bit. To forestall any hesitation — or a careful inspection of the bridge — you might arrange for the delvers to be fleeing from some hideous beast when they come to the chasm.

The bridge will safely support about 600 pounds (the approximate weight of three armored delvers). When this limit is exceeded, the bridge will collapse into the chasm. The characters who fall with the bridge will be caught in a strong net suspended across the chasm about sixty feet below the bridge.

When the bridge collapses, a fan of epic proportions at the bottom of the chasm begins to whirl. The blades of the fan pick up speed very quickly, and will soon generate a blast of air strong enough to whisk the characters caught in the net up towards the ceiling. This will continue until the unfortunate delvers are slammed into the cavern ceiling — and hit a carefully positioned pressure plate.

Hitting the pressure plate causes the fan below to reverse the direction of its spin, creating a deadly suction. This will pull the characters back down into the chasm, through the net (which is not strong enough to withstand the combined forces of gravity and suction) and into the blades of the fan itself. To demonstrate the sound and effect to your players, shove a raw hot dog into a common household fan. Kzzing!

For a bit of (low) class on this trap, place a sign next to the bridge which reads, "Beware of Low Ceiling."

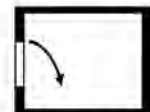

The Teeter-Totter Room is Cliff Baird's contribution to the genre of room traps. Unfortunately, it wasn't designed to kill delvers; instead, it traps them (and in the process turns them into nervous wrecks).

Characters who enter this room may dance, jump up and down, or have a picnic between the door and the pivot point beneath the floor. However, when over half the weight in the room has moved to the other side of the pivot, the floor no longer rests on the support brace near the door. The brace falls away, and the floor becomes a great teeter-totter upon the pivot point.



It is up to you to decide what will happen to the characters if they fall off the floor. As an especially savage variation, have the floor slide off its pivot and follow the delvers into the pit if they blow it.

Michael von Glahn offers the **One Way or Another** trap as a possible ending to the quest for the trap that will turn adventurers every which way but loose. This beauty, while sinister in construction and implication, has certain humorous overtones in application.



The room is your normal type dungeon room. The walkway which runs from the door to a niche in the opposite wall that houses a chest neatly bisects the floor into two pits.

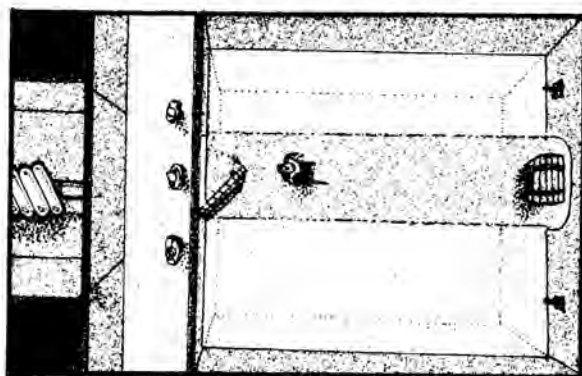

Figure A.
The trap as set . . .

Each of the pits is covered by an illusion of normal flooring that can easily be seen as an illusion. At either side of the niche, just barely out of easy reach from the walkway, is a lever.

In the corridor opposite the open doorway, there is a spring-loaded section of the wall that will be triggered by weight being dropped on a pressure plate in the walkway. The cautious delvers who stand in and around the doorway while someone walks out on the walkway, or while they

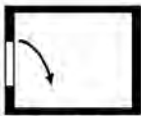
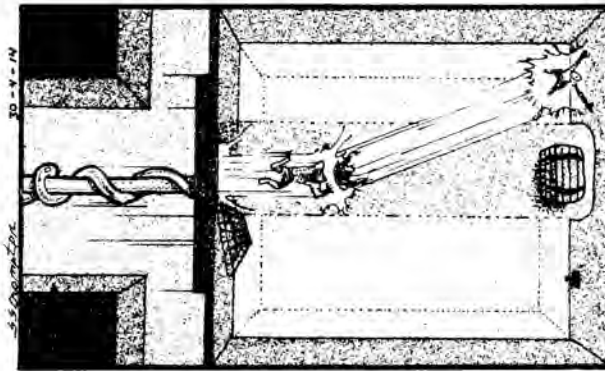

Figure B.
The trap as sprung.



throw the carcass of their latest victim onto the walkway to test the floor, will be rammed by the wall into the room. Those not in the doorway will be splattered against the wall. So much for those outside the room.

Now the delvers who have just been shot into the room, like pinballs being blasted into action, will have to act quickly. It is not likely

that any will fly straight and true at the chest, though you may wish to allow this if your thirst for blood has been quenched. Those who pitch off of the walkway will fall through the illusory flooring into the pit below. Those who fly across the room and grab the levers in a last-ditch effort to stay out of the pit, will find the levers to be easily detachable fakes that they will have lots of time to examine as they fall.

As for any character lucky enough to survive this mayhem, Michael suggests something suitable in the chest to dispatch them. I suggest that GM's select carefully, for the thing in the chest should be like an aperitif after such a heavy meal. That is small, aromatic, and packed with a big kick.



Greg Day has submitted an impairing room trap. The **Toe Tickler** is sure to wreak havoc among those delvers who think of greaves as old and useless.

The room can be entered without mishap – the trap is triggered when the delvers attempt to *exit* the room through either of its doors. The floor of the room drops a foot and the door-side wall of the pit is revealed to have a series of two-inch holes running along it. From the holes come spears that should catch most characters in mid-shin, causing a painful wound if they do not break the shin outright. It should also slow a character significantly if being pursued . . .

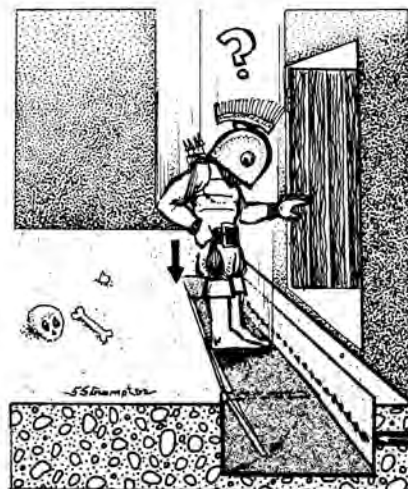

15-3-5

Toe Tickler

◀ Side view

Top View ▶

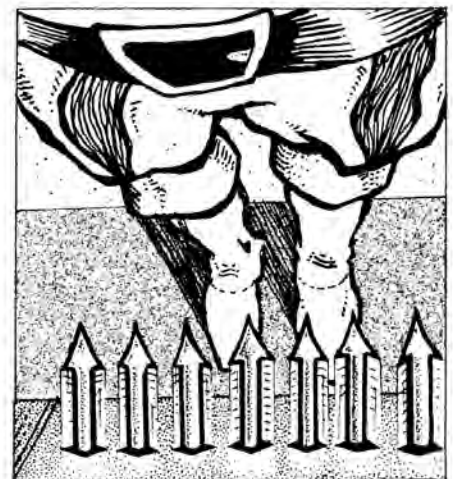

20-2-5-6



Michael Arner brings us the **Fire and Ice** trap. Like many other traps in this section, this trap is harmless until some poor schmuck screws up and does (in his opinion) the sensible thing . . .

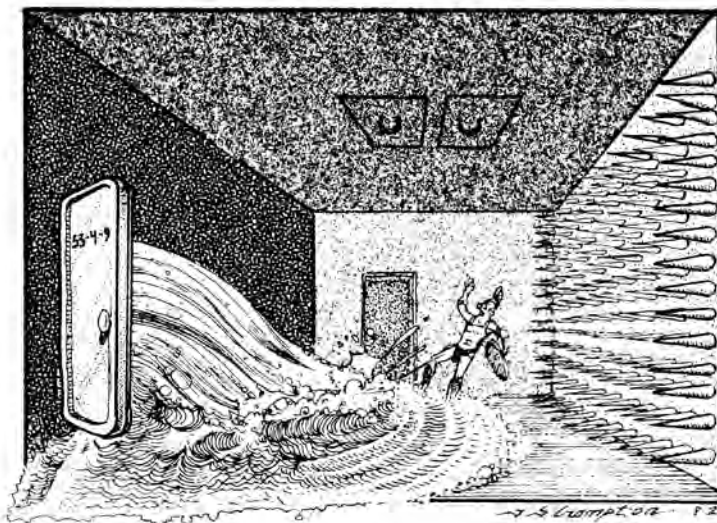

This trap utilizes a small room. Rows of nasty-looking spikes cover one entire wall; in the wall opposite the spikes is a silver door. There are two trap doors in the ceiling. Delvers enter the room through a separate door on one of the unused walls; this door seals and locks itself behind the delvers.

If the party opens the silver door, they unleash a torrent of spring water which knocks them back against the spikes. The water continues to gush from the door and rapidly begins to flood the room. If the delvers survive the spikes, they'll find they must drop most of their equipment to tread water. The room will fill to a level dangerously near the ceiling (and the trap doors).

The safest thing to do is to sit tight. After about five minutes, the water will drain away, allowing the delvers to exit through the now-dry silver door. On the other hand, in a panic situation like this the delvers are probably convinced that they will drown – so they'll try to open the trap doors!

However, both trap doors lead to doom. Behind one trap door is a chamber filled with sodium (an element that combusts upon contact with water). Behind the other is a chamber filled with crystals which cause water to freeze. When either – or both – trap doors are opened, the element behind will be dumped into the water to keep the delvers company . . .

Next in line is the **Door-Lover's Room**, by Caroline J. Maher. This trap uses its own snare as a red herring for its intent. Interested? Read on . . .



Inside the room is a deep pit filled with ravenous, poisonous spiders. Delvers enter the room normally through a standard dungeon door. Narrow greased ledges lead around the pit to the apparent safety of a corridor on the other side of the pit.

When the characters navigate around the pit to the corridor beyond, they'll doubtless feel proud of themselves for avoiding the trap. So much the better . . . within the corridor is a spiral staircase that leads up to a normal-looking door. When the delvers open the door, however, a trap door opens beneath their feet, sending them plummeting down a chute and into the spider-filled pit they've just negotiated! Never go forward until you're secure about what's behind you.

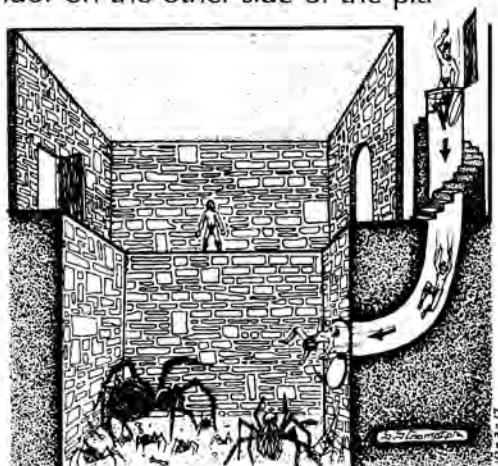

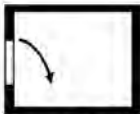

Room Traps

– NOTES –



Larry DiTillio's first room trap is the **See-Saw Room**, a devious variation on Cliff's theme. This trap is tailored to deal with those inconsiderate delvers who like to play interior decorator and move every piece of furniture in a dungeon room.

The room is small and rectangular. Identical stone statues are set in opposite ends of the room; a series of glass globes supported on iron racks rest along the other pair of walls. Behind each statue appears to be a poorly-concealed secret door.

The entire room rests upon a central pivot; the statues keep small bolts in place and keep the room from tipping as soon as the first adventurer enters. If the statues are moved at all (presumably to gain access to the "secret doors"), the delicate balance of the room is upset, and the room will tilt radically to one side or the other. The delvers will be hurled towards one end of the room, and the fragile glass globes will be dislodged from their holders to shatter on the floor, spilling their deadly contents (poison gas/flaming oil/scorpions/whatever you choose). Finally, the stone statue from the "up" end of the room will plummet into the lower end of the room, pulping the delvers caught there. Oh, the fiendish wonder of it all!

This trap could also work as a corridor with a door at its midpoint and a statue at each end "hiding" a secret door. No matter how it is used, this trap is sure to be deadly.

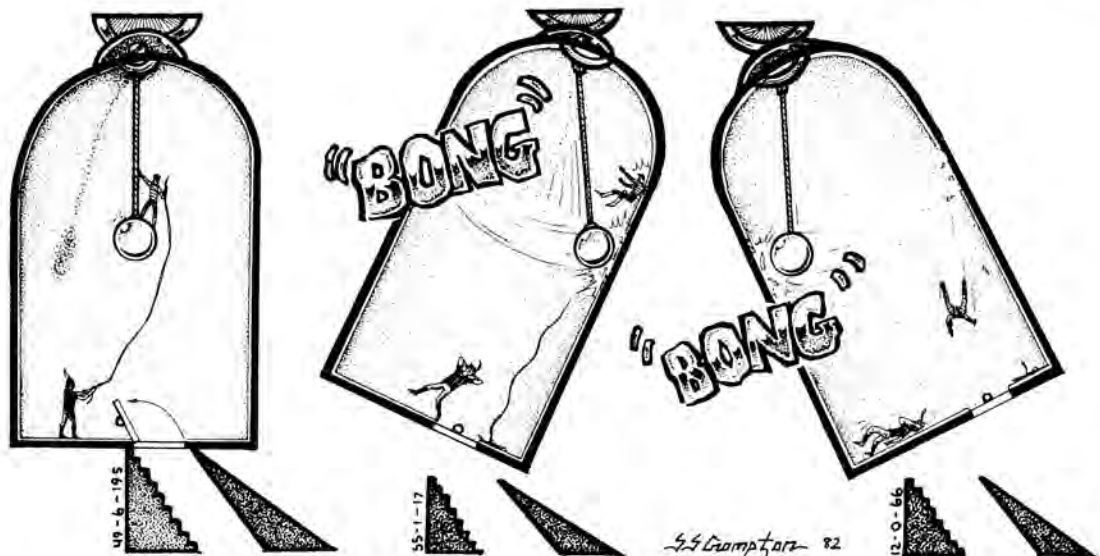

Larry's next trap is the **You Rang?** room. This is a round room (diameter 10') with a 30' high domed ceiling. Hanging from the center of the ceiling, about 10' from the floor, is a golden ball about the size of a beachball suspended on a silver rope. The room can be entered without a mishap through a trapdoor in the bottom of the floor.

If no one fools around with the golden ball, the party will be unharmed. However, doing *anything* to the ball and rope triggers a complex mechanism above the room, and the room begins to swing from side to side – with the delvers trapped inside. The room is actually a giant bell!

The golden ball will strike against the walls of the room (now revealed to be stone-plated steel), making an awful gonging din which should deafen the characters. Those delvers foolish enough to hang onto the ball will be pulped against the walls; characters who merely stand in the swinging room should gather their share of bruises, too.

The bell also serves as an alarm for the monsters in the area. The room will stop

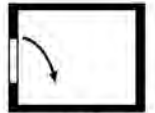

swinging after a few minutes – just in time to admit the hordes of hungry monsters who will have gathered nearby. The monsters should have no trouble dealing with the deafened and battered party within the room . . .

Not content to leave sleeping dogs flat with his low-humor *Low Ceiling* trap, Jason Sato strikes back with the **Dinner Gong**. This nasty room trap is a good way to feed the older monsters in your dungeon who can't beat and eat their meals like they used to.



The trap presents itself to the delvers as a simple dungeon room containing a treasure chest. The chest is securely fastened to the floor, so bands of moving-company dungeon delvers can't haul it away. On one of the walls of the room is hung a large brass gong.

Opening the chest activates a small but powerful generator hidden beneath the dungeon floor. For atmosphere, add a humming sound and slight vibrations in the floor when the generator is started.

The generator powers a strong electromagnet hidden in the wall behind the gong. When the magnet powers up, any iron or steel objects in the room (including armored delvers) will sail through the air into the gong, resulting in a loud "BONNNNNNGGGGG." Delvers will be stuck to the magnet until they can free themselves of their armor.

The sounding of the gong alerts the feeble old monster in the hidden room nearby. Dinnertime! The monster should probably be something with lots of teeth and a can-opener . . .

Peter Yearsley has shown, through his frequent and fascinating letters to FBI, to be a true Renaissance Man. With the flare of an Inquisitor, he has dreamed up this next devious trap. Yankee ingenuity has got nothing on this Englishman's sense of the macabre.

The Hall of the Memorial Carpet is insidious in its application because it is one of those traps where the delvers can see how they will get it, and any attempt to escape will bring it upon them more swiftly. Except for the lucky ones. . .



The room is a standard dungeon room with doors in the east and west walls. In the north wall, there is a small niche with a lantern flickering in it. The south wall contains a much larger niche which is home to a chest. The floor is covered by the Memorial Carpet, an abstract melange of metal, cloth, leather, and perhaps a bone fragment or two.

The ceiling is placed on a time delay as soon as a door is opened. After two minutes have passed, the ceiling will begin to come down and the air pressure will cause both doors to shut. The air pressure in the now closed room will increase as the ceiling drops to where the air pressure will let it. Ears will pop, and the new level of the ceiling will probably be noticed.

If either of the doors is opened, the air in the room

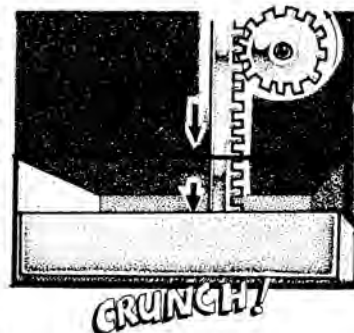
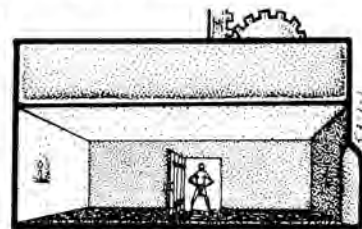



Room Traps

— NOTES —

can escape, and the delvers will become the new additions to the Memorial Carpet. If either the chest or the lamp is moved, a slow leak will develop and the roof will sink towards the floor. Once the ceiling has gotten low enough, the doors cannot be opened, and neither door is strong enough to hold the ceiling up.

The most sinister aspect of this trap is that one or two people could save themselves by standing in the alcoves. What a fight there ought to be for that place of honor. Peter also suggests that an airlock tunnel might be located behind a secret door in the chest alcove. I'd make it an affair that only allows one person at a time. If one delver decides not to, or forgets to close the airlock door on the way out, well, wall-to-wall carpeting is nice . . .

Picture a long room with a door at one end and a bank safe at the other. The safe has been permanently attached to the wall, and cannot be moved. This is the setting for **The Safe-Cracker's Nemesis**, designed by Scot Rhoads.



Delvers, being nimble-fingered little monkeys, will almost certainly attempt to pick the lock of the safe by pressing their pudgy ears against the door and twirling the dial. To the safe-cracker's dismay, however, it will be found that every mistake the character makes while working the dial causes the floor of the room to slide one foot into the wall holding the safe — revealing a bottomless pit below. Too many mistakes, and the gap between the door and the floor will isolate the safe-cracker on the wrong side of the pit! Of course, to be nice you could include a secret passageway on the other side of the safe door, to give the delvers a way out. . . .

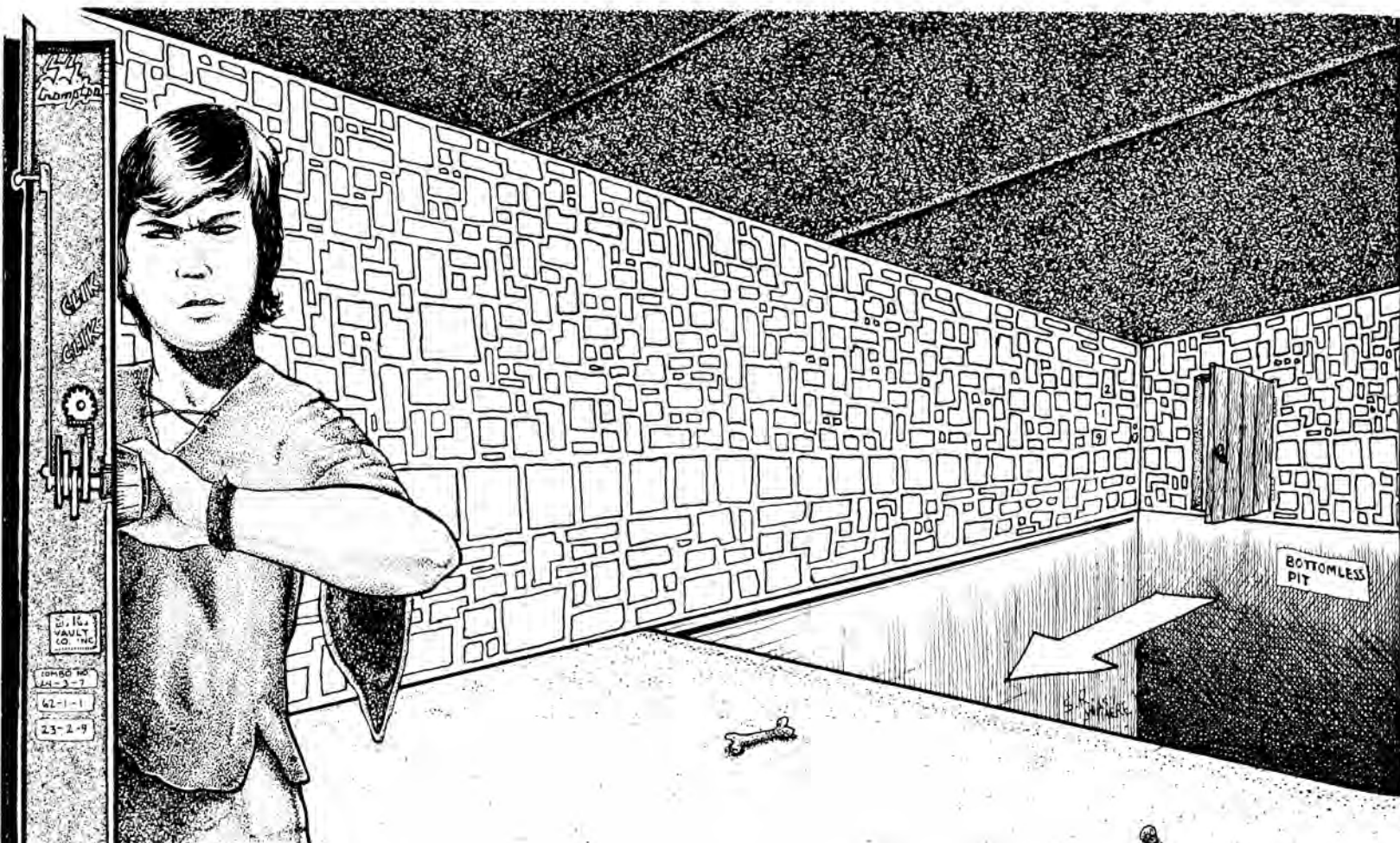

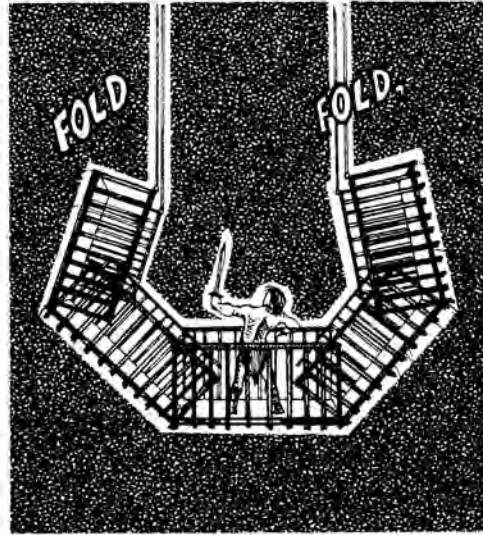
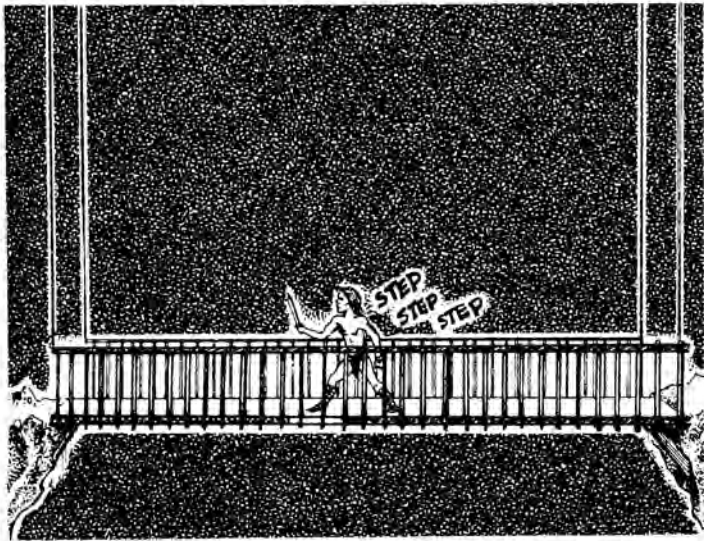

Charles Mollenhauer brings us the **Trolls' Bridge-Work**. No, this isn't a denture for monsters, but rather a bridge over a chasm that quickly becomes a cage hanging over a chasm . . .



The trap works simply. When characters come to the deep chasm, they'll see an easy way to cross it – a wide bridge suspended by wires from the ceiling. Stepping upon the pressure plate in the middle of this bridge causes the sides of the bridge to quickly fold up around the bridge middle, like a perverted draw-bridge. The delvers are now trapped in a cage! You can either leave them dangling over the chasm, or lower the cage to the bottom of the pit (where, presumably, something horrible lies in wait) . . .

From Pat Mueller comes the **Cretin in the Circular Citadel** trap. The intriguing construction of this room should lead to the doom of many a delver.



The trap is a round room; entry is gained by a single door set flush with the wall. In the center of the room, on a raised circular dais, is a glowing ruby of great worth and obvious magical nature. Parading around and around the perimeter of the room are a number of characters of all kindreds and types. These characters all have glazed, fixed expressions on their faces, and they appear to be hopelessly searching for something. Several show signs of advanced malnutrition. There are a few dead bodies sprawled on the floor, as well.

The magical gem places a geas upon anyone who touches it. The affected character can do *nothing* until he or she finds a corner in this perfectly round room. Once a corner has been found, then the character is released from the geas and may take the ruby without penalty.

The various beings wandering around the room are all characters under the geas. Many have died (or are in the process of doing so) during their fruitless quest.

None of these characters (obviously) have discovered the way to find the corner in a round room. By simply knocking a small chunk out of any of the wall space in this room, a corner is formed – thus ending the geas.

But don't tell your players that . . .

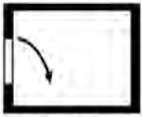

Room Traps

– NOTES –

Andy Beauchamp brings us the **Death of 1000 Slices**, a room of dangerously-positioned cutlery. This trap is so obvious, it's likely to claim many a life. . .

Two opposite walls in a square dungeon room are covered from floor to ceiling with thousands of sharp knives; the other two walls contain doors. Running along the floor, from one door to the other, is a row of knives. Running along the ceiling, exactly in line with the daggers on the floor, is a row of swords.

As soon as a character ventures more than ten feet inside the room, the trap is sprung. If he has walked to either the right or the left of the row of daggers, then the nearest wall folds over onto the floor, mincing him horribly.

The only safe way to walk through this room is to straddle the daggers. This will cause both walls of knives to fall inward at the same time jamming together above the character.

If you want to make this trap even more deadly (a technique which I heartily approve), grease the floor around the row of knives. Thus, even if the delver avoids the walls, he might still slip and fall on the knives! An even nastier addition is to have a voice over announce, in the voice of the party's leader, "Hit the deck!"

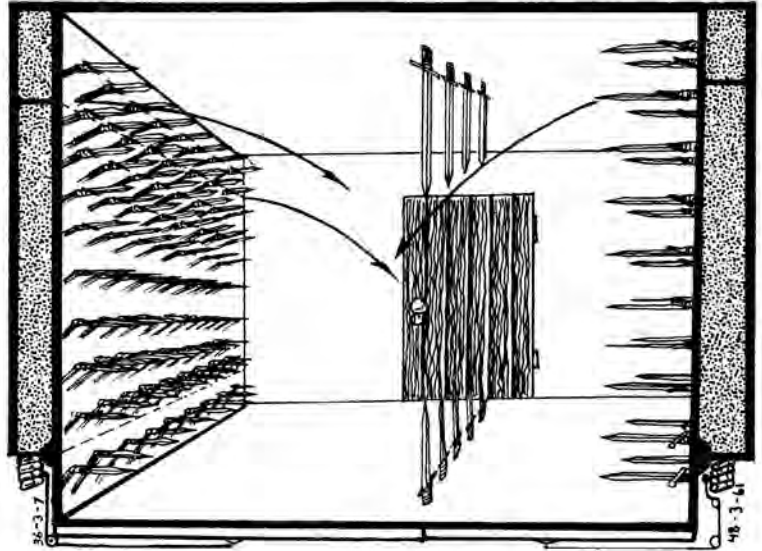

There are often times that a dungeon becomes so familiar to adventurers that they have no fear. They know what is where and can find their way around blindfolded – would that they would do us great favors by travelling that way. Pat Hollister's **Roulette Room** offers us one method for dealing with such carefree wayfarers.

The roulette room is a circular affair with a large number of doors set in the wall. In the center of the room is a chest. When the chest is opened, the room will begin to spin wildly around, quickly making the delvers dizzy and perhaps even throwing a few out through the doors. While this is happening, a lodestone in the chest will hopelessly screw up any compasses in the room. When the room stops spinning – orienting itself randomly to true north – the delvers should be thoroughly lost, not to mention dizzy and sick.

Adding a large silver ball to bounce around and checking if any of the delvers' lucky number is up is purely optional. (If a character's number is up and the character survives, a kind Game Master should pay the character 36 times the amount of money he has on him.)



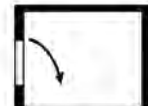

I have often found that the key to catching the most clever of characters in a trap is to provide a trap that is very simple, and provide the adventurers with the solution to it. They act upon that information and, well, see the next trap as an example.

Ted Rassieur offers **The Ceiling Trap**. The room it is placed in is a normal room with one centrally-placed door in each of the east and west walls. The doors are placed directly across the room from each other, and the room is devoid of any furnishings.

When the east door is opened – both doors open out of the room – the ceiling area between the two doors slams down. It should be quite clear to the delvers that if they had been inside the room and opening the door, they would have been squashed. The ceiling then retracts after ten seconds.

When the west door is opened, the ceiling everywhere except between the two doors smashes down. What usually happens is that characters who enter through the east door stand out of the way to open the west door. By the same token, characters entering from the west know better than to stand away from the east door when they open it. Simple, but deadly. . . .

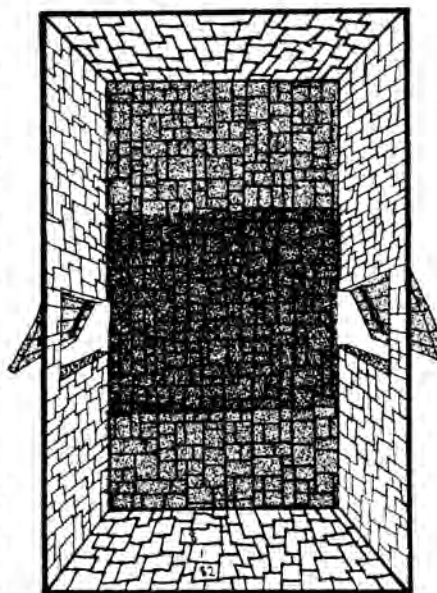

In my quest for traps, I occasionally run across a truly criminal mind housed in the body of a human being. Matt Nadelhaft is like this, and it is criminal that his mind will be trapped in the body of a mere human. He has such trollish potential. . . .

Burial at Sea is a trap for all delvers who do not own wash-and-wear armor. The characters step into a room that smells slightly of brine, yet does not have anything in it. There is a secret door in the floor, however, and what character can resist a secret door? Once the secret door is opened – and it does truly deserve to be called a trapdoor – the fun begins.



Water literally explodes through the trapdoor with the force of a tidal wave. Water will begin to fill the room, making it impossible to open the door to the room. Within thirty seconds, the room itself will be flooded, though the domed ceiling will provide an airpocket for characters light enough to float or lucky enough to fly. Characters who are too heavy will have to shed all of their armor, weapons, and the like until they can float.

A minute after the room has flooded, two smaller trapdoors will open at the base of the walls. One will pump in cold water while the other provides an

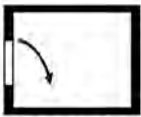

Room Traps

— NOTES —

outlet for the cold water. The cold current will stay at the bottom of the room and should easily push all discarded armor, weaponry, and other equipment (including any loose sacks of treasure) into the outflow hole. After two minutes, the current will cease to flow, and the brine in the room will drain out of the outflow hole. The characters should touch down safe, yet a whole lot poorer. For an added touch of torture, remind them how much brine itches as it dries . . .

Burial at Sea

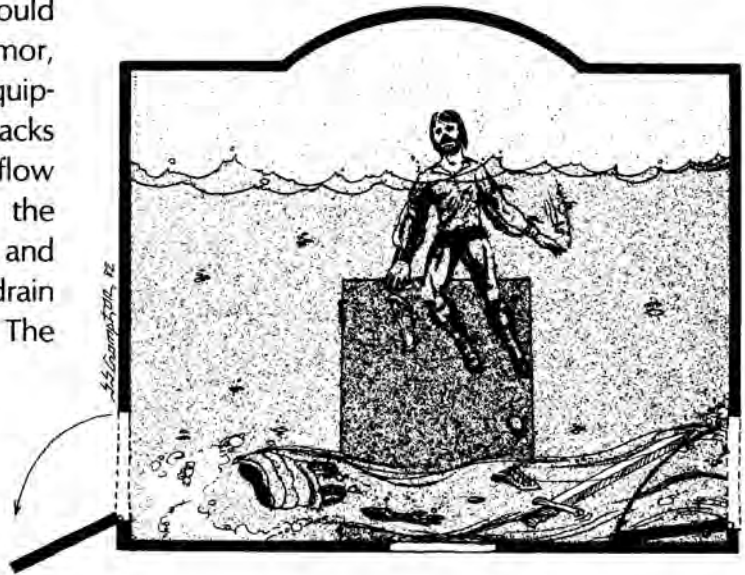

Stephen McAllister, as subtle a dungeon master as I have ever met, has a knack for providing great visual beauty along with deadliness in his traps. Mac is the sort of man who would have thought of putting thorns on roses, if I had not already seen to it. With this in mind, I present **Fruits of Misfortune.**

In a room, the adventurers discover a silver tree that bears golden fruit. The tree and the fruit seem natural to the eye or touch, yet pears, apples, lemons, and such all share the same tree. Little to no magic is felt from the fruit or the tree. The delvers can go ahead and pluck the fruit; it is solid gold, the skin being several layers of gold foil to allow that fleshy feel.

This is where the trick comes in. When the fruit is picked, it will leave a tiny hole where the stem connects to the branch. The silver tree is actually hollow, and gas

will seep through the holes. The gas is of the knock-out variety, one that will affect all races and kindreds; the length of time it takes will depend upon the health of the characters and how many of the fruits have been picked. Worked well, however, the adventurers should not know they have been tricked until they begin to pass out from the gas. Whether or not returning the fruit to the tree will plug the holes is up to debate, though when was the last time a tree took back fruit?

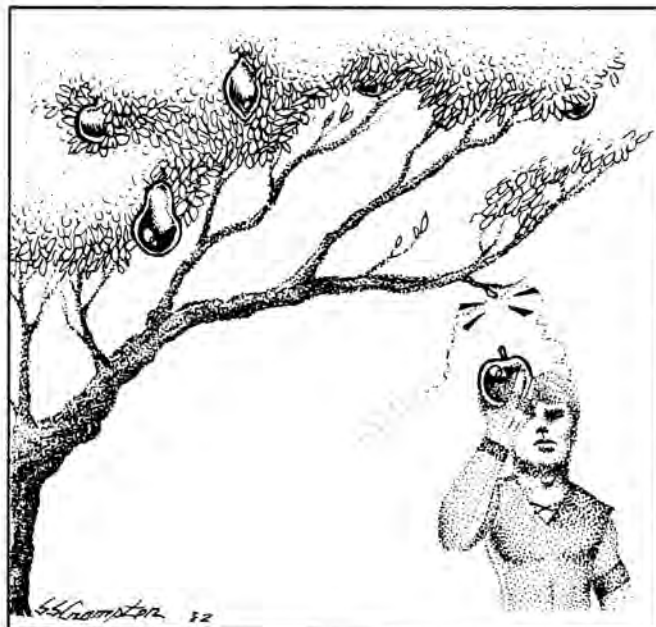



Mike Stackpole, whom I have been forced to deal with since I dispatched my first two editors, has retreaded a concept by Matt Nadelhaft to create the **Let Me At 'Em** trap. All you have to get them to do is push the button . . .

The adventurers enter a small, dingy room through a door in the west wall. The north wall has a very strong-looking man bound to it by a steel band around his middle. As the adventurers enter the room, the captive taunts them with cries of “You sissies, I’ll rip yer throats out. I’ll smash ya all. I’ll kill ya. I dare ya to release me; you ain’t so tough.” The south wall has got a red button on it labeled “Release.”



At the captive’s back, within the band, is a button that his body keeps pressed in. If the release button is hit, the man will be teleported away. This will release the button and allow the north wall to slam into the south wall. If the man has been killed, his body will drop from the steel band – if the release button is pushed – accomplishing the same thing. A grim application of the “deadman switch” principle . . .

Lodes of Fun is a trap devised by Adrian Passmore. Adrian is another contributor from the United Kingdom, and he clearly shows where you American colonials get your deviousness.



Adrian’s trap is located in a small room, perhaps at the end of a cul-de-sac. One end of the room features a door, another wall has a secret door behind which waits a troll armed with something large and heavy. When the plain door is opened, a very powerful fan is activated. It blows thousands of BB and marble-sized lodestones out at the adventurers. The fan is powerful enough to keep all but several strong men working together from closing the door, and it will shut only off when all of the lodestones have been blown off a pressure plate in the base of the lodestone room.

The lodestones will fly out like locusts and cover any armored character. The armor will become heavier with the added metal, and it is quite likely that the stones will block eyeslits or make joints really difficult to move. Most characters will shuck their armor to collect the stones. This is when the troll steps out and greets the adventurers with his weapon.

Also remember that a character stepping into the closet will reactivate the fan and may well be blown across the room by the force of the wind . . .

The Better Mousetrap could only have been born in the mind of Brandon Corey, and many adventurers will wish it had been stillborn. In a room laid out in the shape of an L, there is a huge mousetrap. The spring is the size of a man’s thigh, and the bar that would break the neck of a mouse is fully three feet wide and two inches thick. On the trigger rests a pound of cheddar cheese which radiates good magic. The L-shape of the room is so that the characters cannot initially see what they are going to confront. No character with any sense would enter a room with that big trap.



Triggering the trap is simple: just toy with the cheese. As the bar snaps down, which it will do when the bait is removed, it will hit a pressure plate at its impact point. This will activate the release catch on the doors to cages containing several

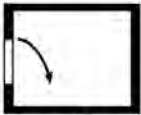

big cats (lions, tigers, catamounts, and such).

As the characters examine the cheese, they will note that the center of it contains a Cats Eye gem. The magic is coming from the gem and will attract cats to the character with the gem. Of course, the cats will only wish to play with this character, and the game they will seem to favor will be ambush . . .

Just as an added surprise, you might have the characters meet the huge mice the trap was set for originally . . .



The Better Mousetrap



Kiss of Death is another trap presented by Brandon Corey which turns the joy of anticipation into the sour taste of reality with frightening swiftness.

The trap needs to be presented with a bit of preparation and can probably best be served if the characters must ferret out information about it from many and varied sources; make it a mystery. The basic rumor to be presented is that if the characters perform a certain ritual and kiss the Statue of the Goddess of Love at a nearby temple, they will become immune to swords and fear. Details of the ritual should be difficult to uncover, but they all should be available to the characters by some means or another.

The statue they must kiss is a huge head mounted on the wall of the temple, behind the main altar. The breadth of the lips must be easily as wide as a normal human head. The head and face are carved from unblemished white marble and are that of a woman who is unhumanly beautiful. The head radiates functional magic.

If the character attempting to gain the boon has completed the ritual correctly and kisses her on the lips, the boon will be granted. Each GM will have to modify the promise to fit the reality of the campaign world being used.

If, however, the character failed some portion of the ritual or kisses a part of the statue other than the lips, the lips will part and a sword blade will lick out like a serpent's tongue. Anyone kissing the lips of the statue should be hit in the face and



probably killed instantly. Characters kissing another part of the face would take the sword in the portion of the body at mouth level. The strange thing is, for those who complete the ritual and for those who blow it, the promise is kept.

Jonathan Bernick has claimed that the inspiration for some of his traps came from Mike Stackpole. Nonsense! In Jonathan's work, I sense an evil genius that causes Stackpole to pale in comparison. This next trap, **Another Brick Through the Wall**, will bear me out.



The room appears to be the normal sort of dungeon room that we have all come to know and love. The doors are in the east and west walls, and the room is devoid of anything. Once the delvers have entered the room, both doors close and lock. The north wall begins to move towards the south and the delvers. It looks as though they are probably going to end their lives knowing how it feels to be a grape in a wine press.

The south wall is really a flimsy construct of plaster and wood. If the delvers do nothing, they will be pushed through the south wall into a small treasure room. The north wall will stop at the old south wall, and the delvers are free to leave.

If the south wall is broken or tampered with before the north wall gets within five feet of it and trips a hidden switch, a steel grating will slip across on the southern side of the south wall. The grating should have wide enough holes in it to frustrate the attempts at bracing the wall with staves, while being narrow enough to act as a delver strainer. The hidden switch will prevent the grating from sliding into place; one case in which he who hesitates is not lost . . .

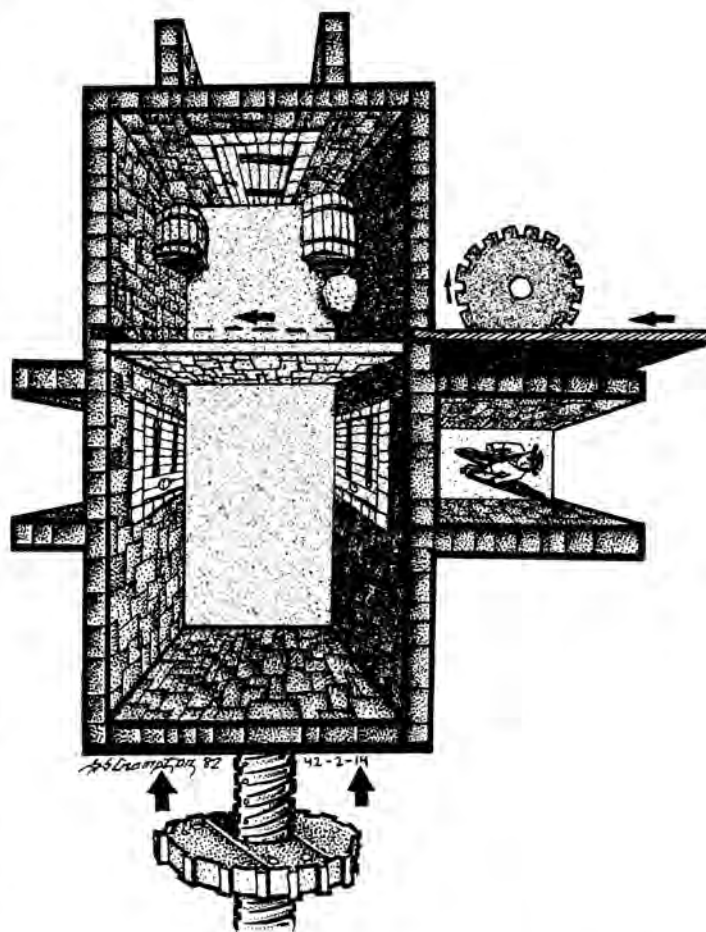

Sink or Swim is a nasty variation upon old themes. With this trap, Lee Russell punishes characters for lack of foresight or thought when something obviously is wrong.



The room to be used is relatively small and probably should be entered through a secret door in the north wall. The floor is grassy, and if the characters dug down, they would find a two-foot thick layer of pumice about three feet down through the dirt. Below the pumice is water. The pumice, and indeed the whole floor, is floating upon this water.

The only feature of this room is located on the east wall. There, a small ledge is set upon the floor. A pipe that looks to be about eight inches in diameter rises from

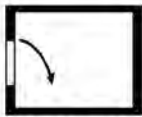

Room Traps

— NOTES —

the floor and is half imbedded in the wall. It is capped and rises to the height of four feet. From the top of it trails a small faucet. A cup is chained to the faucet and a huge wheel is located on the pipe to regulate water flow. Still on the eastern wall, near the northern corner, there is a secret door that is barred on the interior hidden side with a wooden bar.

When the large pipe is opened to allow water to flow out of the faucet, water will also begin to flow out of another pipe branching off and emptying into the room beyond the east wall. The water comes from beneath this room and draining it will result in the floor sinking. Something on the order of spikes should protrude through the sod from the bottom of the water tank, obviously a threat if the floor had drained faster or a character fell from the ledge. Since the north door now has no flooring next to it, reopening it is going to be inconvenient, and the characters will probably begin the search for a secret door.

As seen below, the secret door is there. When the east room fills with the water from the tank below, the bar on the door will float away and allow the door to be opened. The water should rush out again and probably sweep a character or two from the ledge onto the newly exposed spikes. And as the water eventually drains back through the sod, the trap should reset itself.

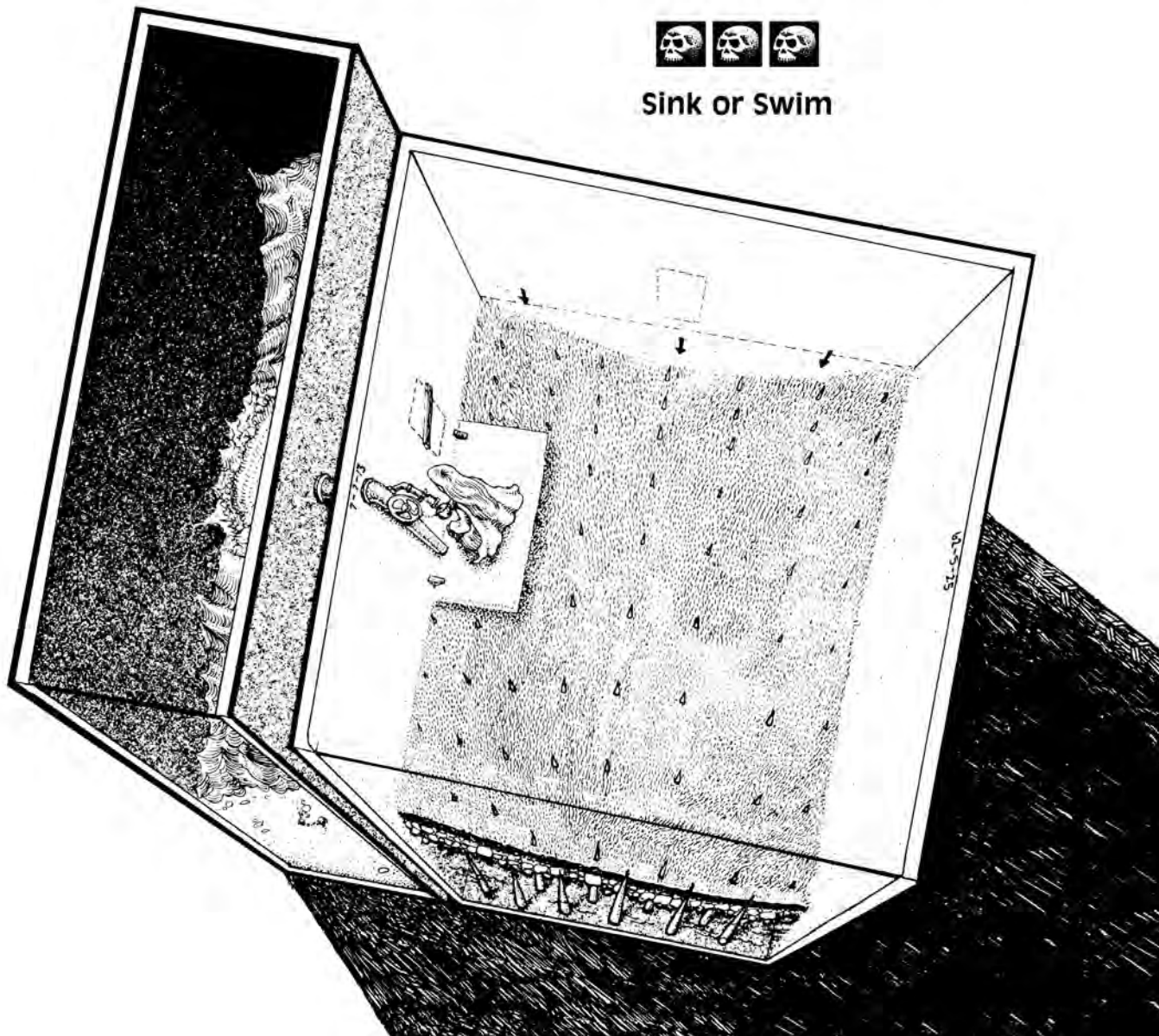

Archimedes' Revenge

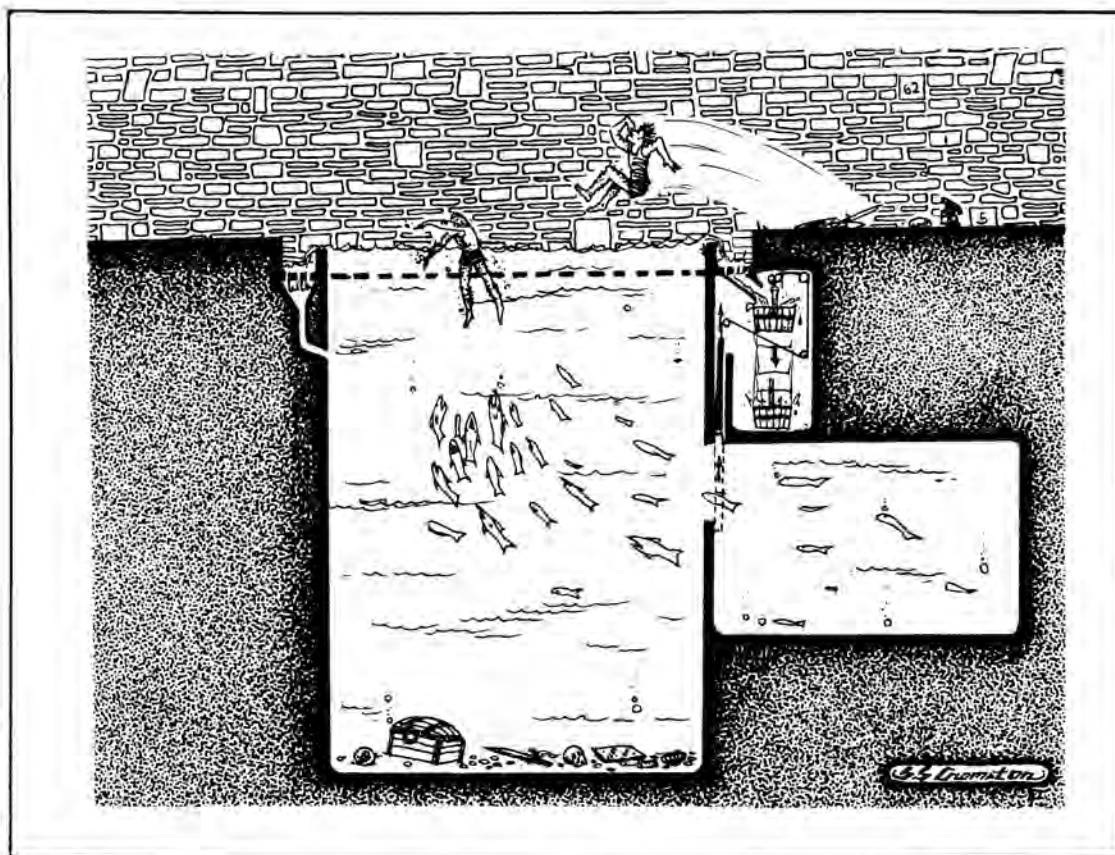

Liz Danforth and Mike Stackpole have teamed up to use sound scientific principles in a trap that shows that they have no principles themselves.

Archimedes' Revenge is a trap centered around a ten-foot diameter well sunk into a floor. Around the outer edge of the well is a one-foot deep depression about two feet wide that would give the impression of a step down to the well. The water is absolutely to the brim of the well, but it has not spilled over onto the step. The well itself is about twenty-five feet deep. The step area contains four drains.

The bottom of the well is strewn with treasure. The water is warm but harmless. Halfway down on one of the side walls, there is a secret panel that can be detected and opened from within the pool.

Anyone diving into the pool will displace a certain amount of water. This water will flow down through the drains to a collection bucket. This bucket, once it is filled with enough water (a gallon or two will be fine), will become heavy enough to pull a pin that has prevented the spring-operated secret panel from flying open. Behind the secret door, you could place a holding tank for piranha, though the designers of this trap also offered molten lava as a possibility that will boil the delvers alive. I favor this latter idea; I prefer my food cooked, though I suppose the addition of a second secret door full of spices would be too much to ask for.



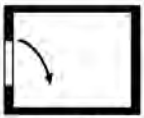

This next little number, called **Shock Treatment**, is certain to surprise characters who believe themselves to be careful. Chris Andrews, the designer of this trap, has a knack for providing a new twist upon ordinary situations.

The adventurers find a room with a fifteen-foot diameter fountain in the center. The fountain features small jets of water from a stone pedestal in the center of the fountain. Upon the pedestal stands a beautiful figure bearing a twelve-foot long spear in an upraised hand. The statue is made of gold-plated steel, and a seam can be seen at the shoulder of the spear arm, as if the arm might be able to move down in a windmill action. The spear point is ten feet above the water level. The water is not poisonous, and the bottom of the fountain is dotted with treasure.

The adventurers will try to avoid the spear arm, fearing a stab in the back as they gather treasure. Indeed, standing upon one of the many pressure plates in the base of the fountain basin will cause the arm to fall, and only the most clumsy of characters will be hit with the spear. If the spear hits no one, it will dip into the water. This is when the large charge of electricity running through it will discharge into the water and any delvers in it as well. . . . A similar thing will happen to the witless soul who tries to scrape the gold from the statue.



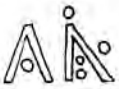

—S. Crampson—

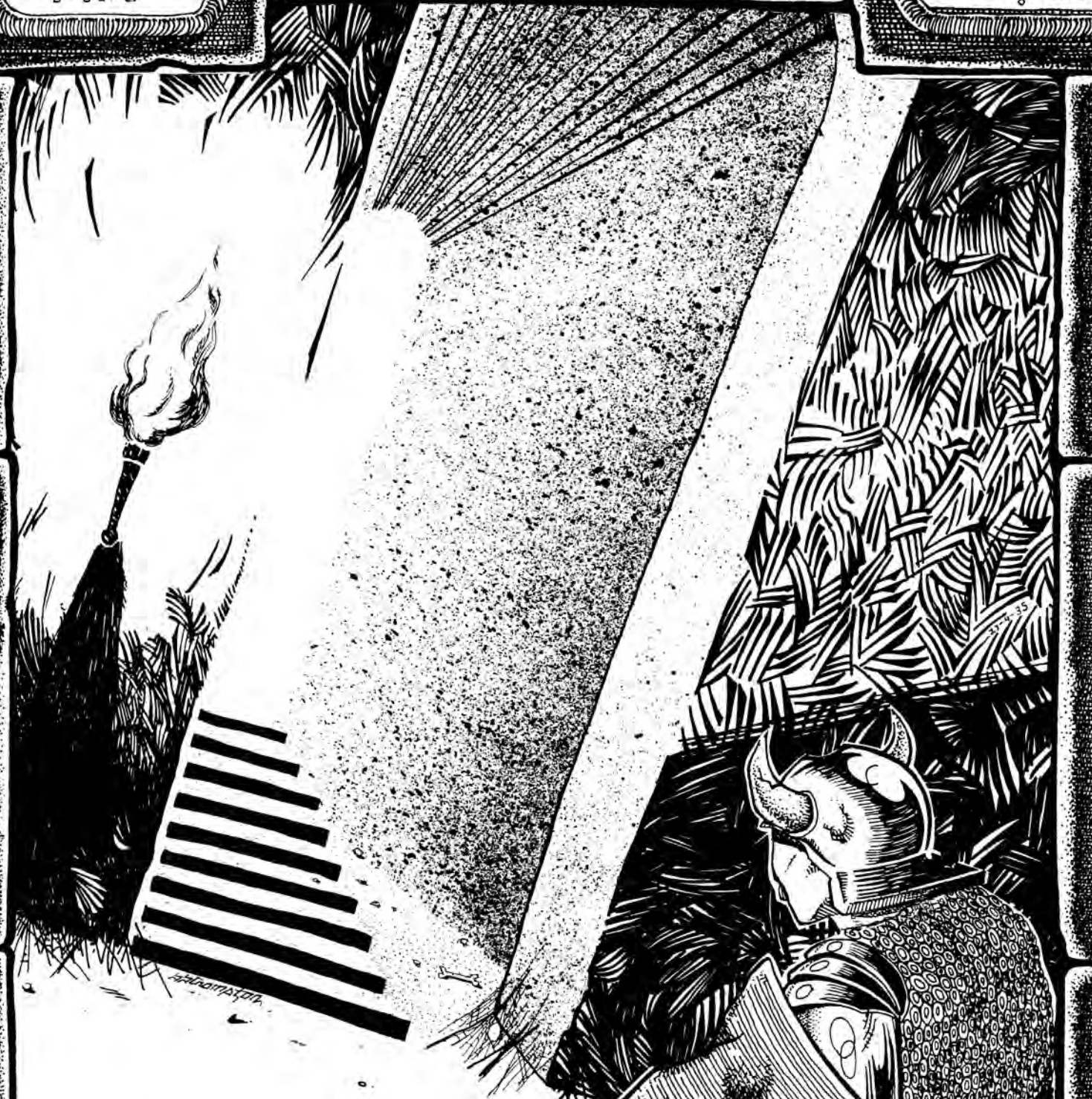
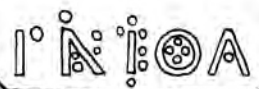

Your dungeon corridors needn't be dull passageways of stone. Employ a few of the designs in this chapter and you'll find your tunnels have become as much fun to explore as your rooms. A hallway is no place to rest – and it's time the delvers of the world realized it.

Corridor Traps

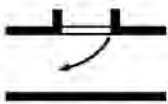

Corridor Traps

– NOTES –



My first corridor trap comes from J. E. Todd. As Mr. Todd points out, most delvers kill the monsters and then take their treasure. **Shower of Gold** turns the tables on this familiar scene, letting the treasure kill the delvers and then the monsters take their bodies . . .

The trap is actually quite simple. In the wall of the corridor is set a lever; posted nearby is a sign which clearly reads "Treasure Vault Release." The trap is set in motion when some fool actually pulls the lever.

Pulling the lever releases the catch-pins which secure this section of corridor, allowing it to split in two and collapse into the pit below. This forms a sort of funnel, which will neatly channel the 4620 cubic feet of gold coins that were hidden in a hollow above the corridor. Assuming gold weighs about 1000 pounds per cubic foot, we're talking about 4,620,000 pounds of gold here . . .

Of course, all this gold has to flow through a 4' x 4' opening, which just *might* give the hapless delvers a chance to avoid the shower.

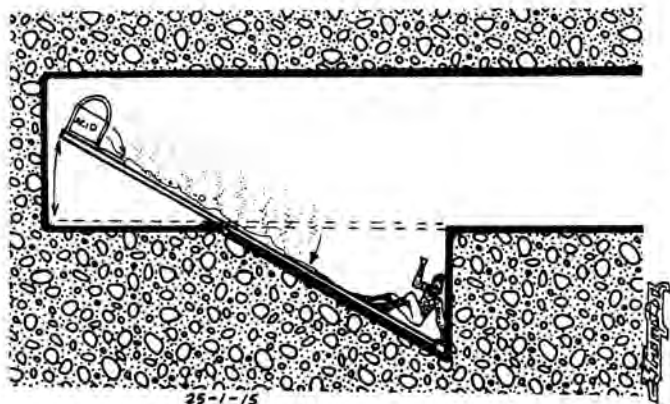

Brian Hammond has developed a grim topical trap called **Acid Rain**. Rather than simply ignore the problem which plagues the northeastern United States and Canada (to say nothing of the rest of the industrialized world), Mr. Hammond has displayed a true sense of dungeon-mastering malice by adapting the phenomenon into a trap. Bravo!

The trap centers around a dead-end section of corridor that balances upon a fulcrum. A false chest stands in the dead end; it is attached to the floor at its base by a hinge. When a delver enters the corridor, his weight will cause it to shift on the fulcrum, dropping down into the pit below. This causes the false chest to flop over on its hinge, releasing its deadly content – acid! – onto the slope. The acid should neatly spill down the sloping corridor and splash all over the unfortunate delver below.

Mark Bassett does interesting things with the next two pit traps. Each is standard in appearance and initial execution, but both get a little strange once they're triggered . . .



The first of these traps is the **Wet Pit**. This is a simple pit which opens beneath the feet of a delver. As soon as the delver is trapped inside the pit, it begins to fill with water, bars spring across the top, and its walls begin to creep together. However, just before the delver is drowned and pulped, the trap resets itself – the water drains out, the walls return to their original positions, and the bars withdraw. A handy ladder then pops out of the pit wall; at the top of the ladder is a sign which reads "You Have Been Warned. The Next Trap Will Be Fatal. Go Home."

Mark has also developed the **Whipped-Cream Pit** trap. If you're tired of adventurers charging into your dungeon just for the glory of it all, you might want to see how brave a tale they can tell about drowning in a vat of whipped cream.

The *Whipped-Cream Pit* functions like a normal pit trap – but instead of containing spikes or acid to finish the clods off, it's full of whipped cream. Whipped cream is too airy to float on, too thick to paddle in, and too slippery to allow anyone caught within to grab a rope easily.

And don't forget the fun you can have, needling a player over the fact that you killed his character by submerging him in whipped cream . . .



A non-fatal corridor trap is the **Moebius Hallway** by Liz Danforth. This trick combines magic and illusion to subtle effect.

This artifice simply uses a moebius strip as a walkway in a hall, catwalk, or garden path – whatever suits your fancy. Some sort of magic is used here in that the feet of characters traveling on the strip never leave it: where a character's feet are is always oriented "down" as far as that character is concerned. Additional magic can also supply the illusions that the world remains right-side up as the characters follow the contortions of the moebius strip.

Once a character has stepped onto the strip, he will walk and walk and walk and (maybe) run – and never get anywhere. When this finally sinks home, the frequent response from most microcephalic delvers is to take a sideways step off the moebius strip. But don't forget the trap – there's a 50% chance that when a delver steps off he'll be the wrong way up in relation to natural gravity! A fall of a few feet onto one's head isn't that dangerous, but should engender a few nasty bruises.

Then again, if the strip has been located on a bridge over a lava trench . . .

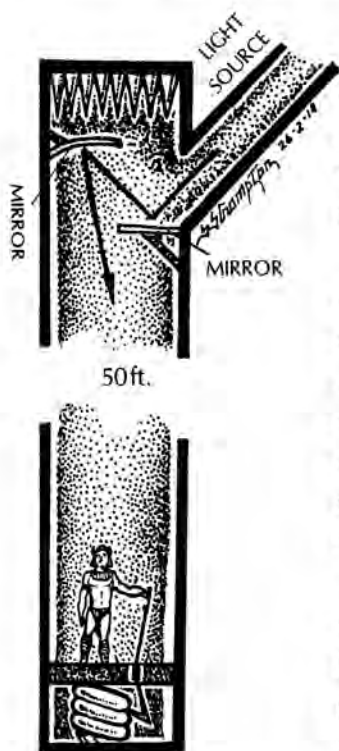

Dan Manning has developed a trap that only a chump would fall for. That means it works like a charm on your average delver. Dan calls his trap **Now You See It, Now You're Dead!**, but I prefer the alternate onomatopoeic title of *Splat!*



This is a homely trap which smashes a delver into several rows of spikes. The trap keys upon the claustrophobic anxiety of a delver who's been trapped underground for a while. When the aforementioned delver sees light coming from a hole in the ceiling, he will doubtless investigate – and discover a lever marked "UP" sticking out of the floor and a ceiling vent which appears to open onto a patch of clear daylight sky.

In reality the "sky" is merely an image produced by a cleverly aligned series of mirrors. Behind the mirrors is a bank of spikes. And when the delver pulls on the lever, the spring beneath his feet uncoils . . . slamming him through the mirrors and into the spikes. *Splat!* No more delver!



And here is a quartet of traps by Michael Stackpole, varying in deadliness from dangerous to exterminating. This is a very trollish attitude; the "safer" traps scare the adventurers witless so that the more dangerous traps will do the job that they're set there for.

Suspension Ladder is the first trap by Mike Stackpole, and it is designed to force characters to think – if they want to stop hanging around. A character finds himself in a vertical tunnel, a chimney of sorts. There is a ladder running up the side of the chimney and light at the top of the ladder. The climb appears to be about sixty or eighty feet up. Each twenty feet of climb takes the character up on a different ladder.

The third ladder is special. When a character gets to the middle of it, the ladder will swing down from the wall such that the top of it will hit the chimney wall opposite the ladder. Two steel cables, thin but high tension wire, protrude from the top of the ladder into the wall where the ladder is normally attached.

The tense part of the trap comes now. All of the rungs, with the exception of the one the character is hanging onto, are built to pull free when pressure is put on them from an angle other than normal when climbing. In other words, while they will work normally for climbing, using them like horizontal bars will pull them free and cause a long fall if the delver has not got a strong grip on the good rung.

The way out of the trap, of course, is to hang onto the outside edges of the ladder and work along that while ignoring the rungs altogether. If the adventurer gets to the cabled end, he will hit a switch that will draw the ladder upright again. If he goes to the other end, the ladder will retract slowly as the balance is changed.



Mike's second offering is a time-activated trap he calls **Step This Way, Please**. It uses the typical human trust that what was once safe is always safe.

The trap is activated by a pressure plate being stepped upon. This will work best in a paved corridor where the plate is actually brick or stone. Once it is stepped on, it will open a secret door about thirty feet up the corridor. Obviously then, the party has found a catch for the secret door. Once the character steps off the plate, the door slides shut.



1st step: opens door

2nd step: releases flame

3rd step: stupifies stepper

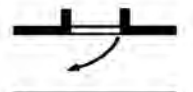

All of the characters will gather around the door while one of their fellows steps on the stone. Whoosh! The door slides open and a blast of flame envelops the corridor up to fifteen feet away. The person stepping on the stone will be fine, but his buddies will be singed. He naturally steps off the stone to cut the flame off. This action should be rewarded; the damage should be less for the characters getting burned. Once they prepare themselves for fire, the stone will be stepped upon a third time. The third's the charm, as a weighted post slams down out of the ceiling to catch the stepper. Flame is optional this time, and yes, the post will keep the door open.

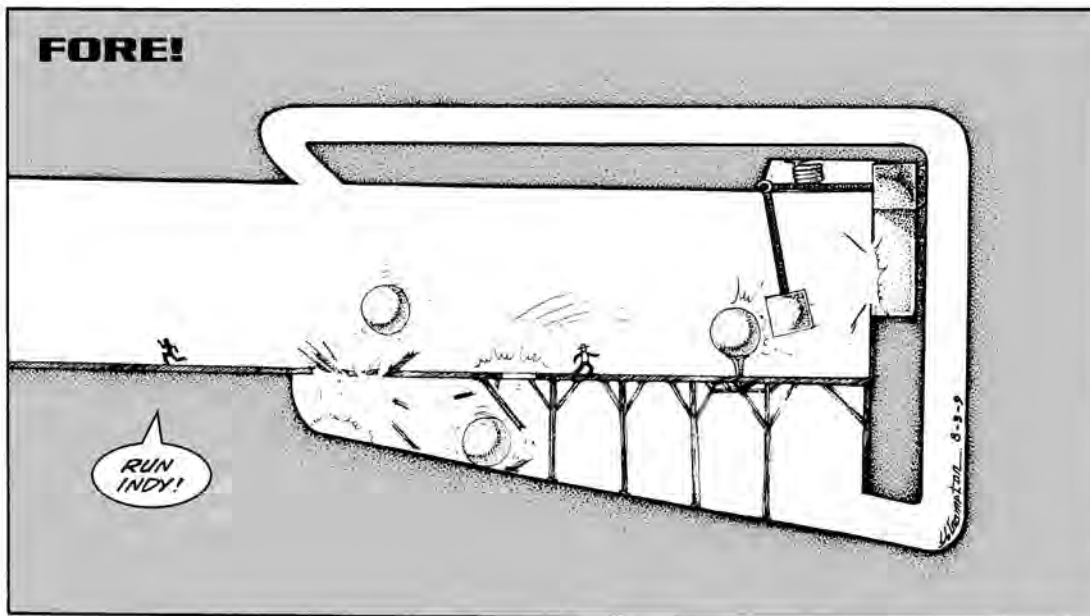

This next trap is a corridor trap only by dint of the fact that most of the action takes place in a corridor. **Fore!** has got to be one of the most unusual traps Mike has ever worked out.



The set-up for the trap begins in a high-ceilinged corridor. There is a thick center beam running the length of the corridor. In the center of the stone-floored corridor there is a perfectly round boulder of granite resting upon a thin, granite pedestal that looks much like a golf tee. To the north, the corridor narrows, and the ceiling drops to the height of fifteen feet. Once the corridor gets smaller, the floor becomes made of wooden planks.

When the delvers hit a pressure plate in the wooden floor, the center beam of the main corridor swings down on a hidden hinge. A large, heavy section of the roof comes down with it, forming it into a mallet of sorts. This hits the boulder which goes flying down towards the party in the smaller corridor. The boulder should land and bounce through the delvers before it hits a weak spot in the wooden flooring and crashes through. Once it has crashed through, it will run beneath the corridor and smash most, if not all, of the wooden floor supports. This should cause the wooden floor to collapse when delvers place weight on it.

To add insult to injury, and to reset the trap, Mike has suggested the addition of a pipe for the ball that will magically accelerate its rate of speed and curve around to launch the boulder back down the corridor towards the mallet that propelled it. If all goes well, the ball will hit the mallet and smash it back into the ceiling while coming to rest back on its tee. If, however, adventurers get in the way . . .

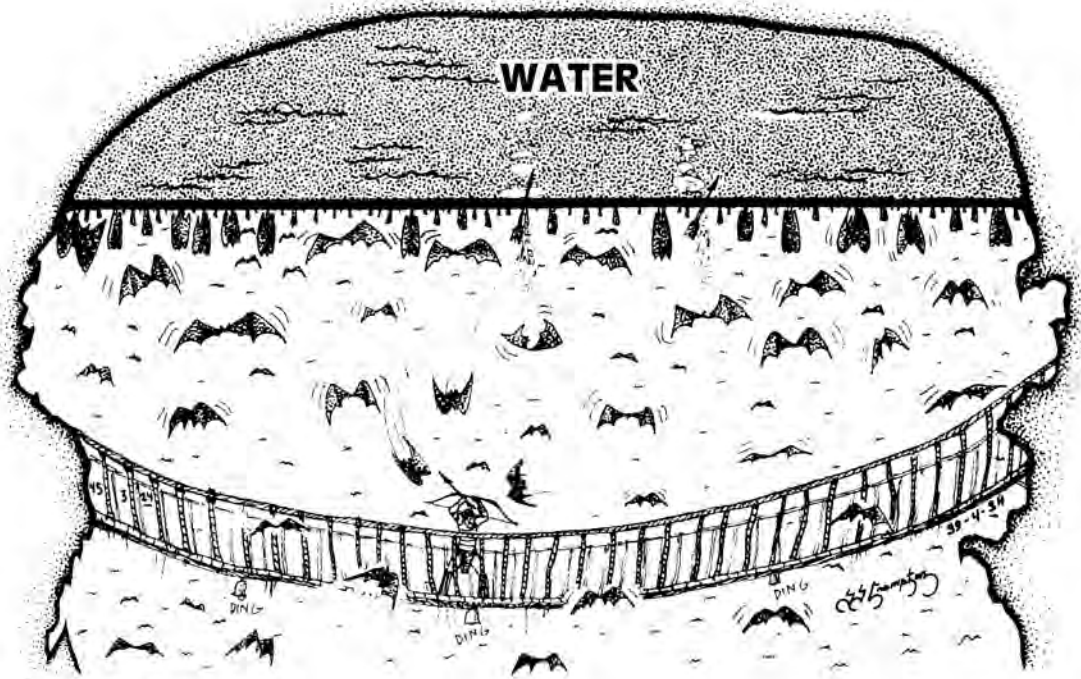
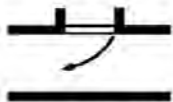

Mike's last trap, **Beware Flash Flood**, goes to great lengths to make the delvers do themselves in. The setting for this trap is a dark cavern with a deep chasm. The sound of running water can be heard from the chasm. Crossing the cavern, there is an old-looking rope bridge. Beside it is a well-worn sign splattered with bat guano that reads "Beware flash floods washing out the bridge."

Above the bridge, there is a huge room full of water. The floor of the room also forms the roof of the cavern above the bridge. The wood has been treated so it will not get soggy, and is held in place by air pressure. The water cannot drain out because no air can get in. On the underside of it, there is the nesting place for hundreds of huge bats.

The bats are herbivores and really not much of a threat to the adventurers. Walking upon the bridge will set it to swaying, however, and that will cause the bell hung on the underside of the bridge to ring. This will awaken the bats and cause them to fly about. Arrow shots at the bats are bound to hit and go through them or miss, hitting the roof in either case. Once that wooden roof is hit, air will get into the upper room and the whole thing falls in one vast flood, quick as a flash . . .

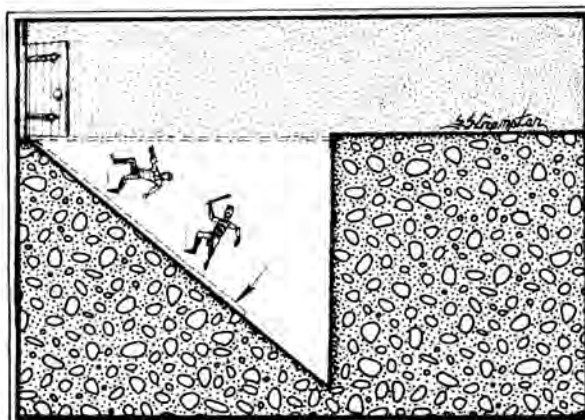

Barry Sullivan has put his devious mind to insuring that the streets are not safe anymore. I like his style; he takes fairly simple ideas and presents them in a way that is difficult to anticipate or avoid.

His first effort, titled **We All Fall Down**, takes the idea of a pit being triggered by opening a door and makes a big production out of it. Any

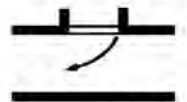

attempt to find the pit near the door will fail, because there really is no pit. Instead, when the door is opened, the length of the hallway within twenty feet of the door slides down into the floor space. The adventurers are trapped, a captive audience to await your pleasure.

Barry's second trap, the **Beer Barrel Stairwell**, combines the simplicity of a pit trap with the power of a siege machine. As the unsuspecting adventurer plods up a set of stairs, his foot breaks through a step. Breaking the board will release the pin holding several large beer barrels on the slightly inclined slope at the top of the stairs. The barrels will begin to roll and bounce their way down the steps, careening into the lead adventurer (remember that trapped leg). They'll probably crack and break open, the splintered ends providing a threat to the delvers below.

And what if their cargo is corrosive . . .



Matt Nadelhaft designed **Hit 'Im Where He Ain't**, a trap that gets the adventurer coming or going. This trap can be located in any corridor that looks innocent and harmless (don't they all?). The delver will step on a pressure plate which causes two things to happen. Above the pressure plate, a section of the ceiling swings down and away from the delvers. From that section of the ceiling, a set of spears drop. The lucky character will actually dive forward. To step backwards is a problem.



At the same time as the spears are falling, the section of the floor the delver has just passed over will slide to the side. A rack of spikes will be snapped up into place behind the delver, blocking the corridor. If the delver jumps back, bang, impaled by his own weight.

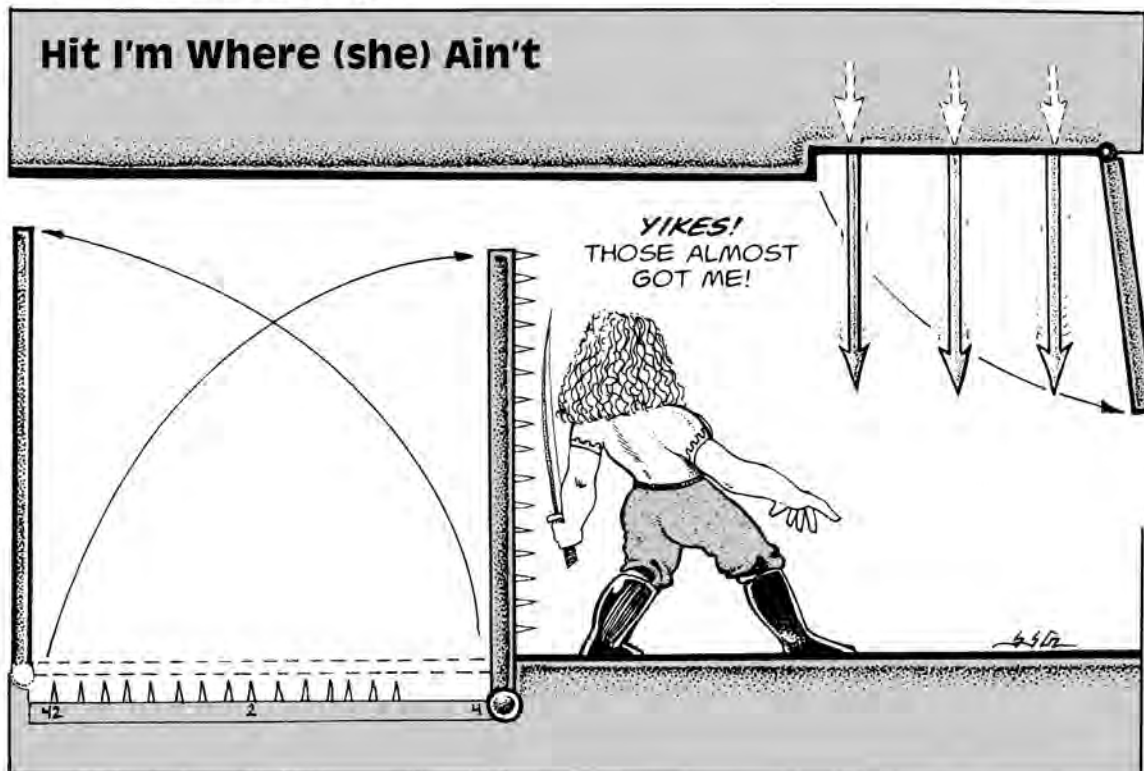

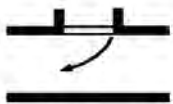

Corridor Traps

— NOTES —

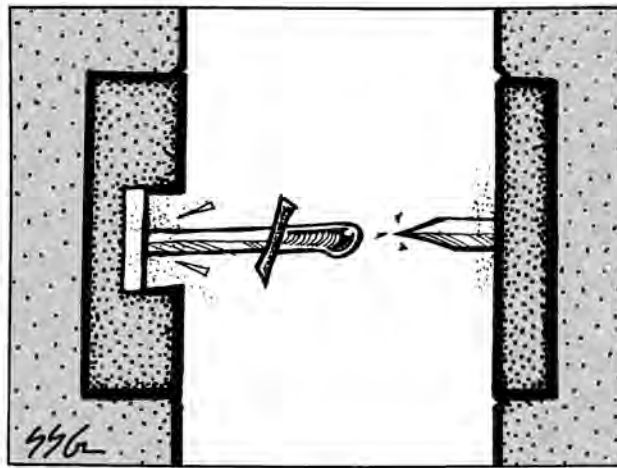

Matt's second corridor offering is another do-it-yourself doom called **I'll Take a Stab at That**. This trap is located in a very narrow corridor where the characters may well have to move sideways to pass. As they move through the hallway, they notice archer's ports on one side of the corridor. Peering into the port will reveal a set of glowing eyes very close to the port itself. A bit of magic will be sensed by

those able to do so. The port is backed with a teleportation field that will make anything thrust into it appear directly across the corridor. If, then, a sword is thrust at the eyes in a northerly direction, it will reappear from the south wall travelling north. That should carry it right into the back of the character wielding it. And if the fields work reciprocally, woe be to the character who turns and thrusts at the wall behind him . . .



Peter Yearsley, having smashed delvers with his room trap, now gives us **Oil's Well That Ends Well**, a method for broiling them to a turn. I think this man would be great fun at a luau.

The delvers are forced to open a door into a section of hallway running east to west. At the far end of the corridor, there is another door similar to the door that they have just entered through. The doors are thick and heavy panelled affairs that are specially constructed. Each door is really a hollow reservoir of oil. The wooden paneling in the door will accept a crossbow bolt, but the bolt will pull free under 80 pounds of pressure. This will cause the oil to come pouring into the hallway. The backing for the oil reservoir is a layer of stone or steel that will prevent a bolt from ripping all the way through the door, the outer face of the door having been panelled to hide the steel shield.

The middle of the corridor has an eight-foot long firepit that completely occupies the corridor. There is also a three-foot high invisible wall (magic or of very thick glass) that begins at floor level and cuts the corridor in half above the firepit. Heat pours out of the pit, the shimmering of the heat waves helping to conceal this wall. The pit is full of red-hot coals.

The north and south walls of the corridor are thin patinas of stone that hold back still more oil. These reservoirs will come

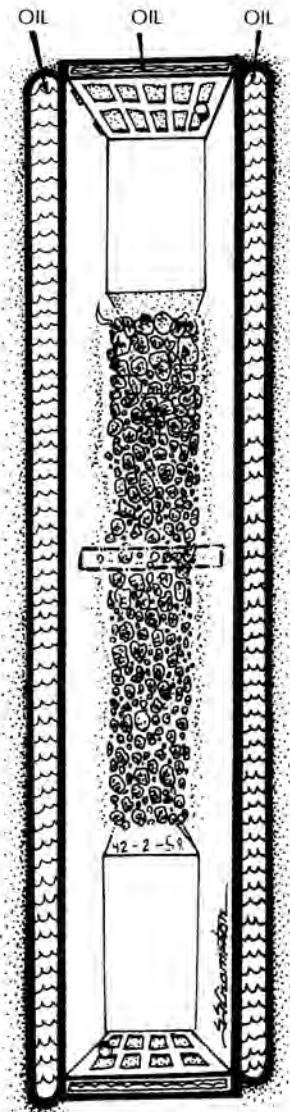

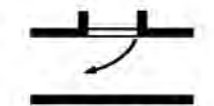

into play if anyone begins to tunnel around the pit or sinks pitons into the walls to aid climbing around the pit.

Every method for getting across the pit, save flying, teleporting, or walking, has been accounted for and has been provided with a flaming reward. A character who jumps will probably catch the invisible wall in the shins and pitch face forward into the far side of the pit. To damage the doors or walls works as well as pouring gasoline (petrol) on a barbecue. Door damage will also sink a pin through the bottom of each door, locking the characters in until they can batter the door down.

Of course Peter does provide a way around this inferno. Walking across will trigger the magical formation of an invisible walkway that will allow passage without harm. Fiendish, and you wondered why the sun never set on the British Empire . . .

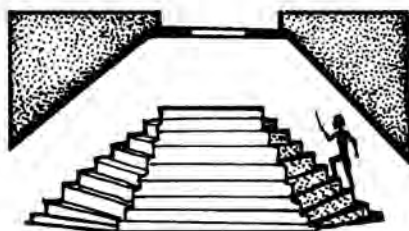

Brandon Corey has offered us another trap that is certain to earn him more electro-shock therapy. It is called the **Russian Roulette Stairway**, and it is no stairway to heaven.



The adventurers are presented with a narrow stairway going up at a 45° angle. The steps themselves are slightly rounded and are

bracketed on both sides by walls. There are no handrails. As a delver climbs the stairs, he will hit one of several trigger steps that will cause a multitude of effects.

The reason for the stairs being slightly rounded is because the adventurers are looking at one of six possible faces to a stairway carousel. Hitting the trigger step on any one of the six faces will immediately cause the stairway to rotate to the right and put into effect the trap on the next stairway. In other words, hitting the trigger on set one shifts the stairs to set two and causes the trap in set two to go off. A tad complex, but the need for this type of deception is vital.

The first set trap is to have the stairs flatten to a slide. When all weight is removed from the slide, the steps will reset and be prepared to trigger set two.

Set two will cause the steps to heat up and toast the toes of characters on the stairs.

Set three will freeze, a nasty effect if the feet have been roasted on set two.

The fourth set will swing around and present the characters with a pit. The bottom of the pit is the trigger for the fourth set; anyone landing on the pit bottom will cause the stairs to whirl again. The people in the pit will then be trapped.

The fifth step is probably the most cruel. The trigger step for it will collapse, sinking a character knee-deep in the floor. As the stair turns the character becomes much shorter.

The sixth and last set has a amusing magical effect. All characters over six-feet tall will have their height cut in half and anyone shorter than six-feet will be

DELVERS ARE
JUST A FEW
STEPS AWAY
FROM THEIR
OWN DEMISE...

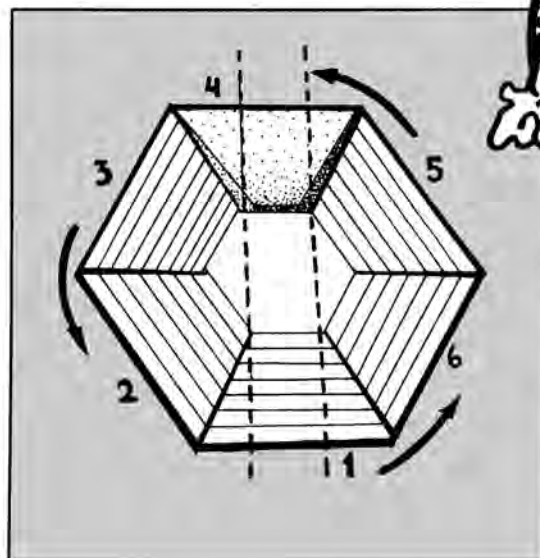

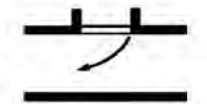

Corridor Traps

– NOTES –

doubled in size. Two trips on this set should be enough to get everyone back to normal, but it can be fun.

One last word about the characters trapped in the pit. They can, by jumping up and landing at the same time on the floor, cause the stairs to turn. Whether or not the stairs open onto more than one corridor is up to you, but that might well be a way to capture or divide the party you are coursing.



The **Spring Slab** is a floor trap by Cathy DeMott that should work quite well in a corridor. The trap consists of a two-ton monolith which rests on top of a powerful spring. When set, the monolith fits neatly into the floor – but if someone steps on the stone, the spring is released, sending the stone (and its cargo) into the ceiling with great force. The stone then drops back into place, causing the spring latch to catch and reset the trap for another crew of unwary delvers . . .

Fred Meyer is responsible for the next three traps. I recommend that you install these only in tunnels where the walls are already darkened or stained, as these traps have a tendency to dispatch delvers in a rather messy way. After all, you don't want to give away any clues as to what's ahead.



Fred's first trap is the **Bee-Hive Trap**. You can place it either in a dead-end corridor or on the ceiling of any hallway. The characters are likely to be a bit apprehensive when they spot the operating factor of this trap – a steel bee-hive with many perforations – but the gamble here is that such an odd object will make the delvers curious enough to abandon their normal caution.

The trap itself is activated when a pressure plate a few feet before the hive is



stepped upon. This causes the hive to fire over one hundred half-inch steel darts down the corridor at a dismaying speed. The darts will bounce off stone but will rip through flesh and most armor, resulting in total chaos in the section of corridor about five feet away from the hive.

For depravity above and beyond the call of duty, you can make the darts rusty or coat them with poison – or do both! – to ensure that even the merest nick will be painfully fatal . . .

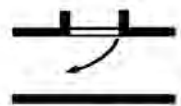

Corridor Traps

- NOTES -



Fred's next trap, **The Double Scythe**, is no less heinous; the Grim Reaper (a distant relative of mine) gets them coming and going. If you want your killer traps to leave their victims in handy bite-sized chunks, then this is the trap for you.

Stepping upon a hidden pressure plate releases two scythe blades – one from the ceiling and one from the floor. The blades skim through the corridor at a sickening speed, in opposite directions. Even if a character is wearing armor thick enough to turn or stop the blades, he still faces the very real danger of a broken back from sheer impact damage alone.

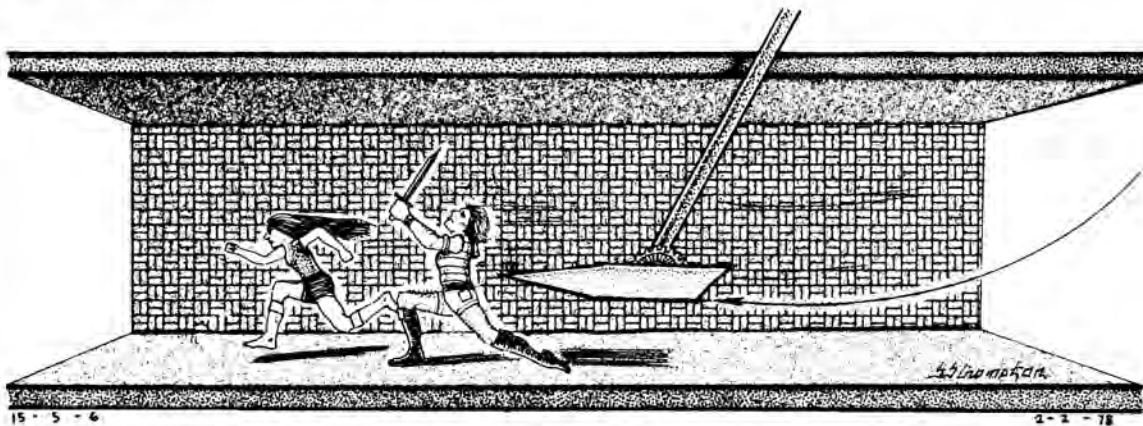

Fred's final corridor trap, **The Pendulum**, is similar to *The Double Scythe*. However, it was designed to decimate a drove of delvers, rather than a single character.

This trap is also activated by a pressure plate. However, instead of scythes, a long, large pendulum is released from the ceiling to swing down the length of the corridor. The pendulum bob is a wide, flat blade (similar to a hatchet) and fills the corridor to less than 6" from the walls on either side. At the beginning and end of its swing, the blade should catch characters in the upper body; near the midpoint of the swing, it will hit knees and ankles. Considering the weight and velocity of the pendulum, it should slice neatly (or not so neatly) through almost anything.



James Walker, the smiling, cherub-faced demon of fantasy games, has offered **Pyromaniac's Comet** as an exciting way to torch those who love battering everything to death. The delvers find themselves in a long, dark corridor. Torch or lamplight will reveal twinkling pieces of quartz set into the floor. It could almost look as though the characters were walking upon stars. Down at the far end of the corridor is a newly constructed brick wall. A block is missing from each of the two lower corners as well as the middle, and two bricks are gone from the top row.

As the characters move down the hallway to investigate, a wall will silently slide up from the floor and cut them off. This quiet wall has two squares cut from it that

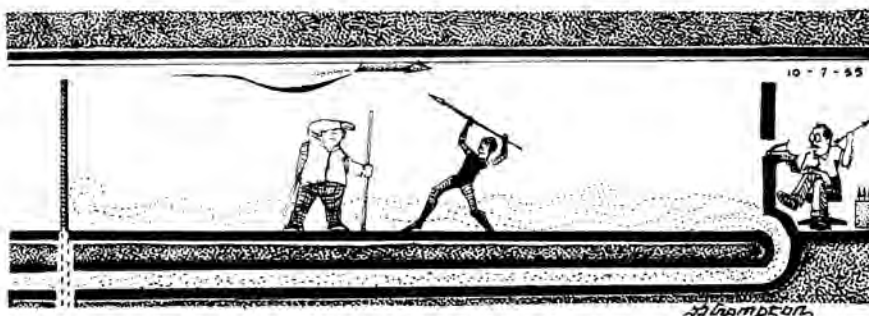

correspond to the two top bricks missing in the wall. In sliding up, it opens two channels that will allow natural gas to flow out of the lower holes in the brick wall.

Natural gas, being odorless and heavier than air, will flow into the small section of the hallway unnoticed and hover around the legs of the characters. Short characters may well fall prey to this gas; lucky them. They won't be around for what follows.

On the ceiling, running through the openings on both walls, there are two tracks. Down each track, literally fired from a secret hideaway near where the characters enter the hall, will come gunpowder rockets or flaming arrows. If left alone, the rockets and arrows will pass through the gassed area and cause no problem. If, however, they are batted from the sky by spell or weapon, the introduction of fire into a natural gas pocket should prove interesting.

The reason for the hole in the middle of the brick wall, you ask? As the party members scrunch to the middle of the corridor to avoid the rockets, they line up perfectly for crossbow practice by any monster in the area.

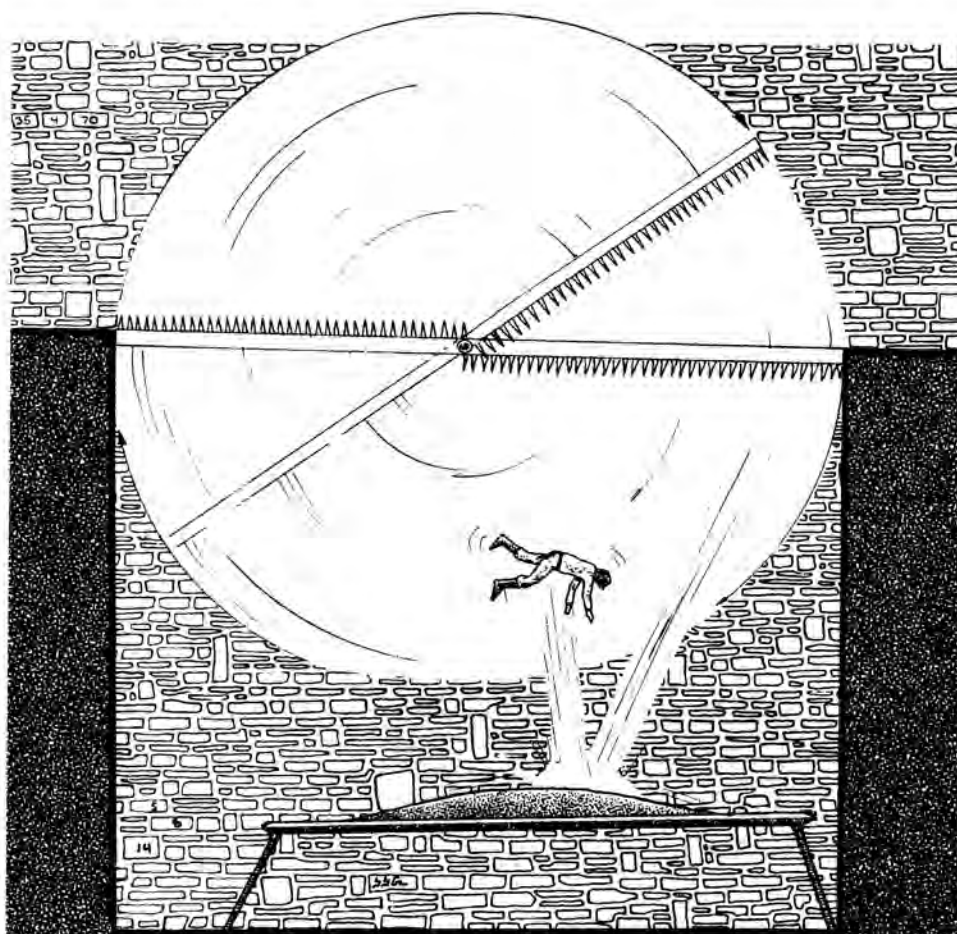

Larry DiTillio has designed a pair of corridor traps for this chapter. Each is truly bizarre – which should make them uniformly successful in any tunnel complex.



Larry's first corridor trap is the somewhat ridiculous (yet deadly) **There and Back Again**. This trap appears to the delvers as a veritable cornfield of 5' high wooden stakes poking up out of the floor. This section of floor, in combination

with an equal expanse of corridor floor in front of the stakes, forms an immense swinging trapdoor which covers a deep pit.

When a delver comes to within a few feet of the stakes, he will upset the balance of the trapdoor and drop into the pit below. As this happens, the trapdoor will continue to swing around and re-cover the pit – with the spikes facing down! Meanwhile, the delver will have hit the trampoline at the bottom of the pit. He bounces back up and onto the spikes, causing the trapdoor to flop back into its original position with the delver messily impaled upon the spikes . . .

Larry's second corridor trap, **The Mangler**, is also his most savage. Its title tells it all, it was designed to bend, spindle, and mutilate most any delver.

The trap is activated by stepping upon a pressure plate. This causes three tempered steel rods to whip out from the nearest wall at three different heights. The two end bars move in one direction; the middle rod moves in the opposite direction. They should catch an average-sized human in the knees, the small of the back, and the head – simultaneously. If such treatment doesn't kill the character outright, it should certainly cause some severe changes to his or her "alignment" . . .

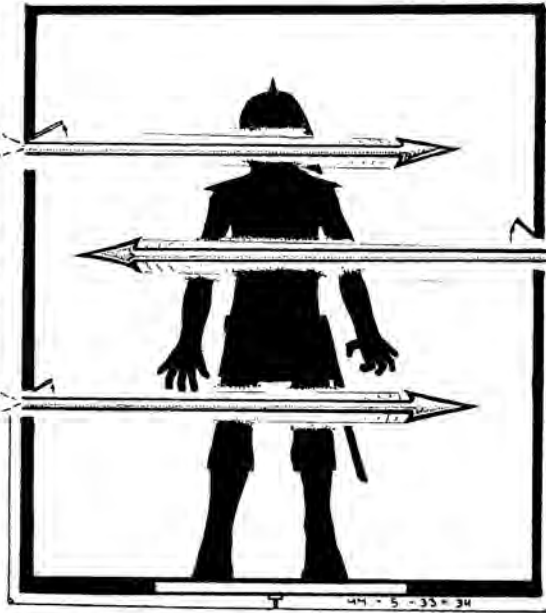

Brian Marrs brings us **Rocky Point**, a pit-and-stake trap that not only adds insult to injury, but adds injury to injury as well.

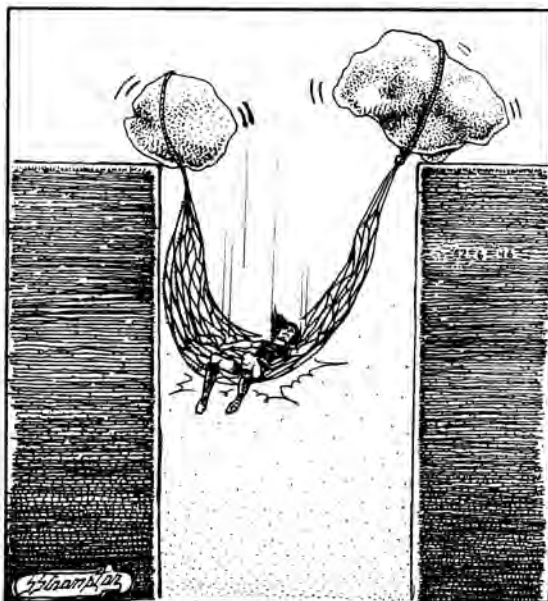

insult to injury, but adds injury to injury as well.

The trap is sprung when a hapless victim tumbles through a trapdoor in the floor. A short fall lands the delver in a net; unless he is unusually light, he'll dislodge the net – and the two heavy boulders which were attached to the net and precariously balanced on a narrow ledge. When the delver hits bottom, he'll be impaled on the stakes below, with nothing but stone above for comfort.

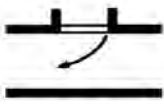

Corridor Traps

– NOTES –



Only Time Will Tile is a corridor trap by David Steven Moskowitz. The setting is a long corridor with an object of great value displayed enticingly at the far end. The floor has been decorated with marble tiles which are separated by wide patches of grout or plaster; the tiles are placed just far enough apart so that a character must leap from one to another to remain on the tiles.

Whenever a delver steps on a tile, a stream of poisoned darts shoots from a nearby wall, passing within inches of him. The delver will doubtless think his alertness and agility have saved him from certain death – but the darts are *supposed* to miss. However, they should encourage characters to step off the tiles and onto the plaster.

The marble tiles are actually the tops of pillars in the room beneath this corridor – and the area between the tiles is only a thin layer of plaster. The result: when a delver puts his full weight onto the plaster, he'll fall through the floor to whatever doom awaits him below . . .

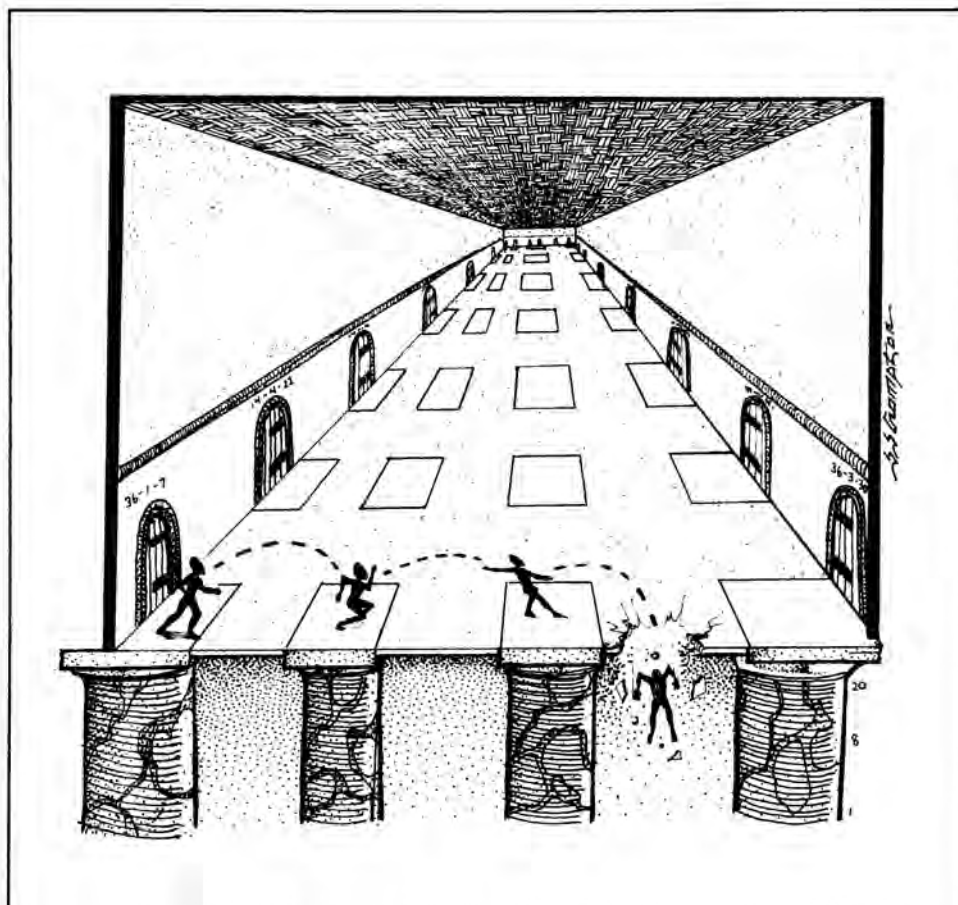

P. D. J. Wright offers us the British eye view of a nasty pit trap entitled **Meet the Pit**. As there are many ways to skin a cat, most of them painful, this trap shows us that there is more than one way to pit a delver.

The pit is a mere six feet across and as wide as the corridor itself. The delvers may walk to the edge of the pit and look in to see the bottom 25 feet below. The pit may be filled with anything – the sharper, the better – making the pit obviously something to be avoided. And what delver is going to be daunted by a leap of six feet?

The trap comes in when the delver lands on the other side and finds that the



other side was an illusion. Even nastier is the idea of building the opposite lip of the pit up of balsa wood and plaster, a construct solid enough for coins to land but weak enough to collapse under the weight of a jumping adventurer. Below the false lip is a 45° slope leading back into the pit. After sliding down the slope – perhaps it is studded with razor blades or hooks – the delver should have a fall of 12 feet into the bottom of the pit he just avoided.

We have met the pit, and we are his . . .

Ken St. Andre has come through this time with a number of strange and interesting traps. Ken says that his first two traps are so fiendish that he's never used them on anyone. I really must have a talk with that boy. He's slipping.

Ken's first trap is called **In Case of Fire**, and it is set within a long, 10' wide corridor. One wall of the corridor is rough-hewn stone; the other wall is clearly made of tempered plate glass. It is very dark on the other side of the glass, but from time to time delvers will see tiny lights moving about randomly. If they watch carefully, they might even see a huge suckered tentacle swipe across the glass . . .

The corridor floor is paved with brownish-black chunks of stone that make walking slow and difficult. Noxious fumes rise up from these rocks, making the delvers' eyes blar and water. In point of fact, these blackish stones are lumps of coal liberally soaked in kerosene – and the slightest spark will convert the corridor into a raging inferno.

Painted in huge red letters on the stone wall is the message: "In case of fire, break glass."

At this point, smart delvers will turn tail and flee. However, since everyone is still inside the corridor, things get interesting . . .

When the party has picked their way about ten feet inside the corridor, an orc who has been observing them from the far side of the hall will fling a shuttered lantern onto the coal. The lantern will break, igniting the coal, and the corridor will quickly become an oven. Only those characters immune to fire can hope to live for more than a few seconds.

If (by some fluke) a delver should act with

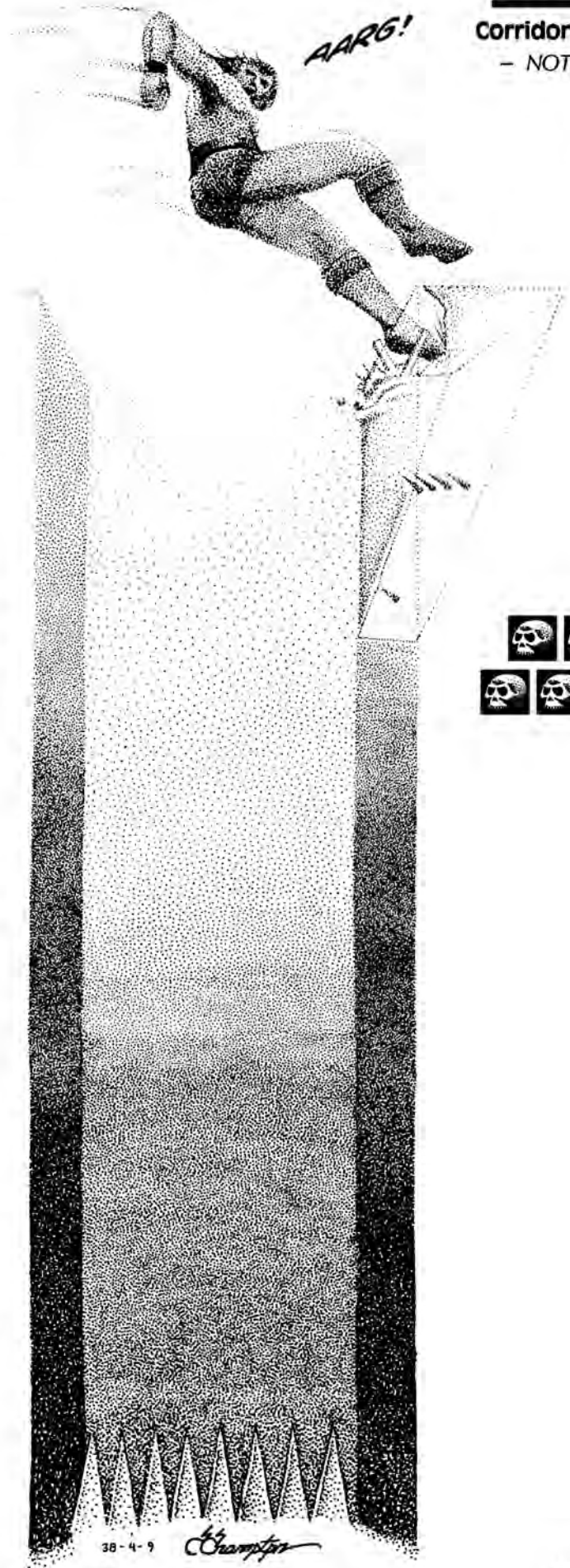

AARG!



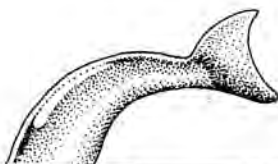
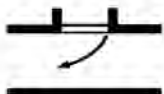

great presence of mind and smash the glass wall at the first sign of flame, the sea behind the glass will rush in to fill the corridor. For the first few seconds, water hitting the coals will turn to steam, converting the entire corridor into a vast sauna that should boil even the toughest delvers alive. The fire will then be extinguished – but now the hallway is filled with water (you may want to install watertight hatches on the corridors near this trap, unless you actually want to flood your whole dungeon!).

Some mega-characters may actually claim to survive the fumes, the flames, the boiling, and the drowning. If that's the case, remind him that there's still an enormous kraken lurking in the water beyond the corridor (remember that tentacle?). Whatever gaming system is being used, the kraken should be about as tough as monsters can get. Bye-bye mega-character.

Suffice it to say that unless a delver can teleport out of harm's way at the first sign of trouble, he's a goner.



Too Many Tentacles is another trap that uses the sea and kraken seen in the previous trap; however, it's probably located in a different part of the dungeon. These two traps could be thematically linked together to provide the final obstacles to a quest for some fabulous undersea treasure like Davy Jones' Locker or an old army boot.

The trap is a strange corridor that is about six feet wide. One wall of the corridor is beaten iron with a number of barely perceptible cracks (the delvers will have to search diligently to find them). The opposite wall is made of a soft gelatinous substance that seems vaguely magical in nature. It has a pink glow and a nauseous stench, and it feels cold and clammy. Beyond this wall of slime lies the ocean – and the kraken – as described in the preceding trap.

The corridor ceiling cannot be seen, for suspended from it are thousands of whip-like tentacles. These tentacles extend to within three feet of the floor, and they are in constant motion. Each tentacle is about as tough in combat as an average human and can deliver a powerful, poisonous sting akin to that of a medusa jellyfish.

As if this weren't enough, the floor of this corridor is also booby-trapped – it's a jungle of pressure plates. Some of the plates release clouds of poisoned needles. Some activate trap doors which drop characters into pits filled with spikes fouled with gorilla dung. Others set off mechanical chakram-throwers that fog the clear

Too Many Tentacles

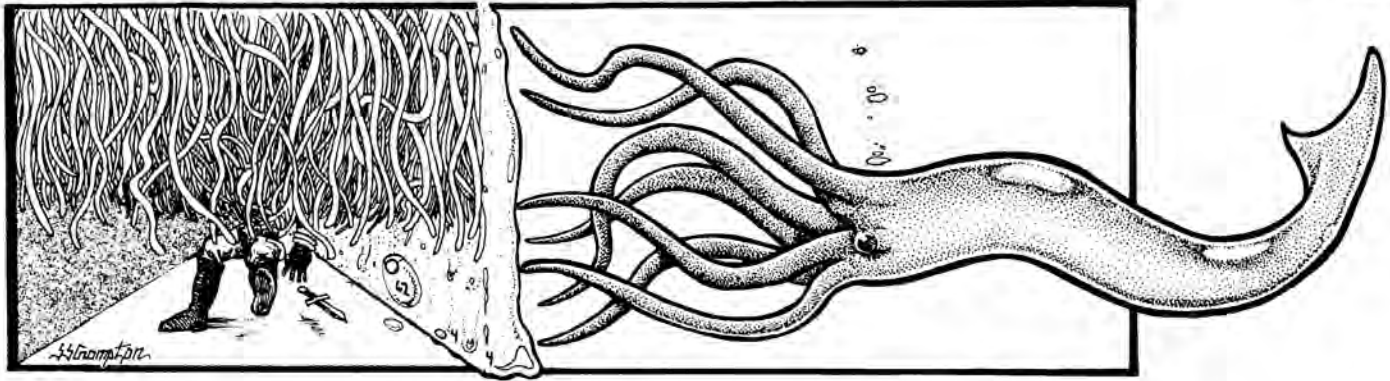

part of the corridor with whirling disks of death.

After the delvers have survived about 150' of pressure plates and tentacles, the *true* horror of this trap strikes. A very large pressure plate causes a 100' section of the steel wall to slam across the corridor, smashing into the delvers like a charging behemoth and driving them through the gelatinous wall and into the sea beyond. The sudden pressure change should make almost any delver explode like a cherry bomb. Failing that, there's always the kraken waiting around for din-din . . .

Those characters who are stuck inside pit traps (beneath floor level), or who are thoroughly entangled by the tentacles near the ceiling, will be fortunate enough to avoid the steel wall by virtue of being out of its way. If they can avoid the spring-loaded steel wall in this manner, they should find themselves behind it in another section of the dungeon if and when they escape their present predicament. After a decent length of game time (say, five minutes), the trap will reset to catch the next group of characters to wander through . . .

Ken set aside his obsession with tentacles and other creepy crawlies when he designed this next set of traps, all of which depend upon the theme of a dungeon interconnected by chutes and slides instead of stairs. You can do a lot of interesting things with chutes, and I'm having some installed next week . . .

Ken's first chute trap is called **Chute the Loop**. It utilizes a long, steep chute which curves abruptly at the bottom, executes a large loop, and then dumps the slider back into the chute on his downward progress once again. By placing a levitation spell on the upswing of the loop, you can keep whatever poor fool of a delver who gets stuck here looping around and around until he either dies or is rescued.

Next on Ken's list is the **Amazing Ginsu Chute**. This is a very slippery chute that is barely large enough for a good-sized human to fit into. Just before the chute ends, it splits into two chutes half as large as the original. The dividing line for the chutes is a razor-sharp blade. The sliding delver's own momentum should provide enough force to neatly bisect him when he reaches the parting of the way . . . If the character is wearing heavy armor, the razor won't harm him; however,



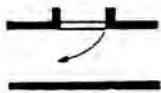

Corridor Traps

- NOTES -



the impact will probably knock him silly enough to try to climb back up the slippery slope, whereupon he'll simply slide back down again (doubtless becoming more and more simple-minded in the process) . . .

Dead End adds a nice twist to your typical chute trap. The chute is large enough for one or two characters to enter at a time – and, as might be expected, terminates in a wall of spikes ready to impale whatever slides down to meet them.

However, this trap has an added feature. Halfway down is a spring-loaded guillotine blade which is triggered by the weight of a passing delver. After a character flashes by, the blade will shoot out and cut any rope which may be trailing back to the entrance of the chute . . .



Ken's next chute trap is called **Emergency Exit**. Near the entrance to this chute, post a sign saying something like "Emergency Exit – this chute is guaranteed to get you out of the dungeon alive." The chute itself should be very long – thousands of feet, at the very least – so that the delver must spend several minutes sliding through it in total darkness. When at last the chute ends, the victim will whiz out of a hole on the face of a cliff that's at least 500' high. The character has indeed exited the dungeon alive, and he is in fine shape if he can only fly. Otherwise, the exit has indeed caused a real emergency . . .



A **Chuting Gallery** is a nice item to install in your orc barracks, especially if you want to provide your poor monsters with some interesting entertainment.

The chute looks normal – but instead of ending at the bottom, it turns abruptly upward to propel its contents into the air. The delver will rocket out of the darkness of the chute and into your brightly-lit barracks, where a squadron of orcs will be waiting with crossbows to blow him out of the air like a clay pigeon. Even if all the orcs miss their shots, the delver must still contend with slamming into the ceiling. And don't forget the orcs themselves, who will be understandably upset at their failure to feather their target . . .

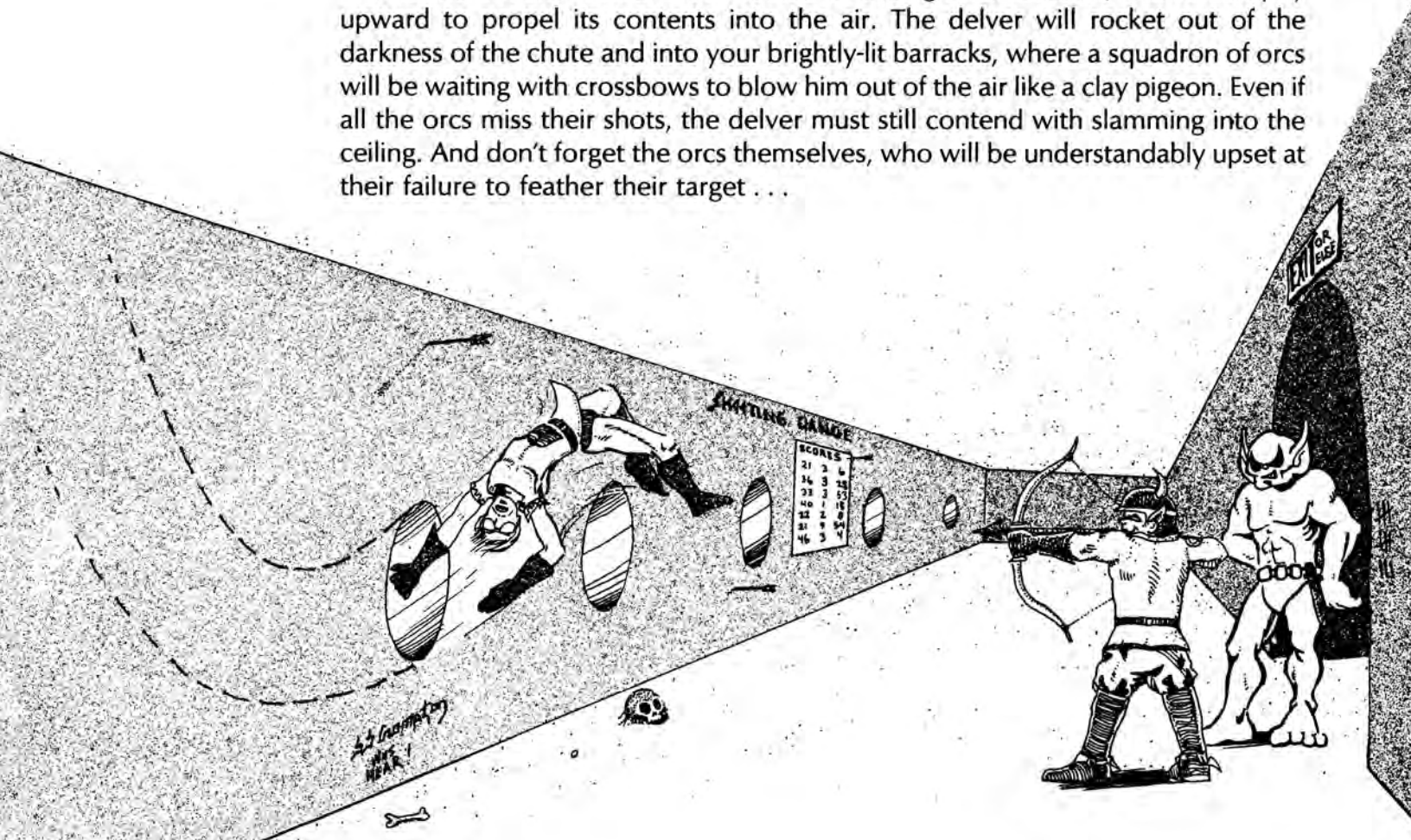

SCORES	
21	6
14	3
23	15
40	1
22	2
21	8
46	3

:i:AO:

S. S. Crampton

:i:i:~D

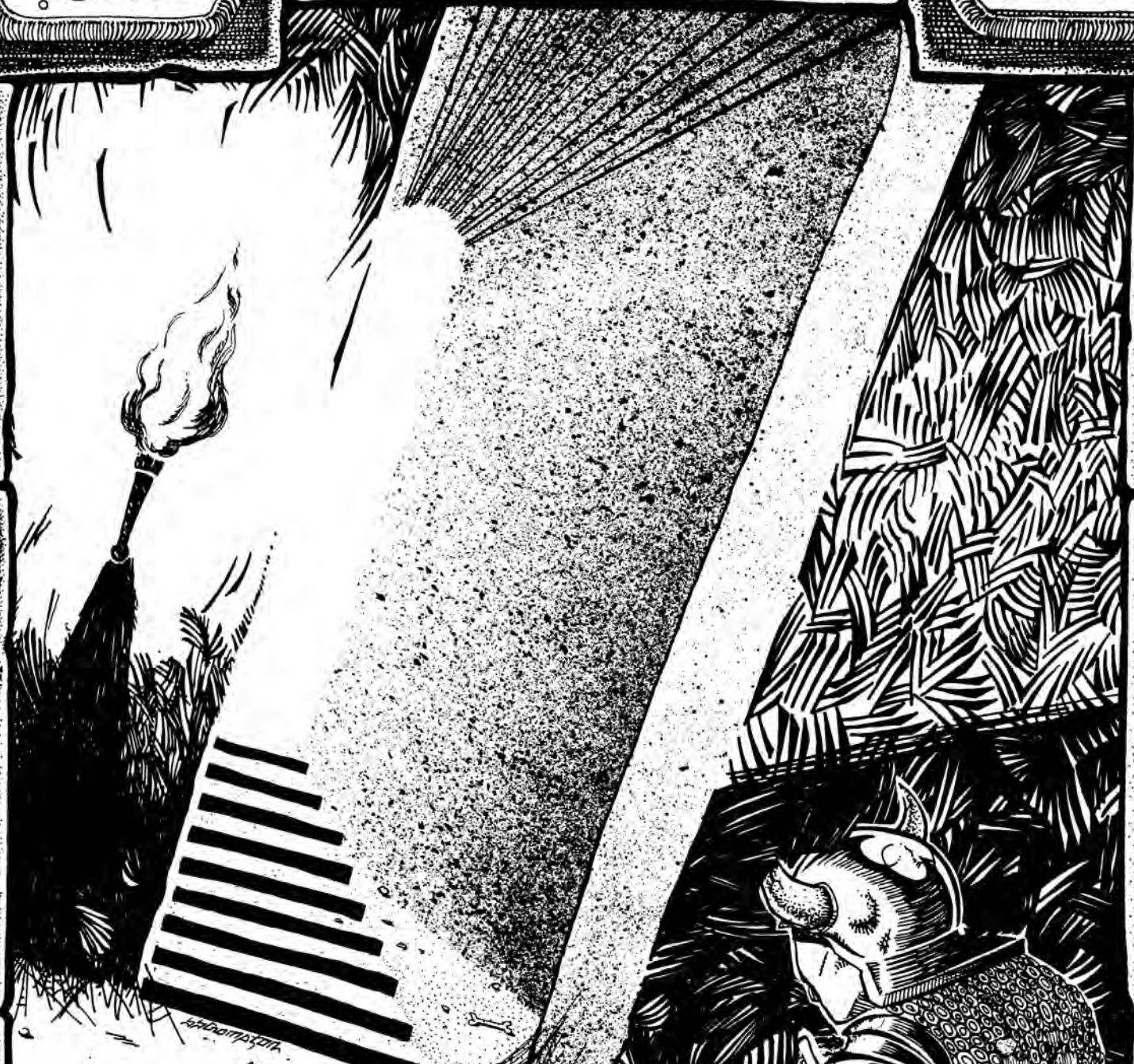

Dungeon masters seem to love door traps more than anything else in their worlds. I suppose there's something inherently hysterical in watching delvers get diced by door jambs. But it seems like such a worthless way to go . . . door traps seldom guard anything of worth — rather, they frequently lead the way to still more gruesome traps and dangers!

I've put several of the following traps to their best use at the front door of my cave. I change the door every once in a while; so far, I've bagged three salesmen, fifteen religious fanatics, a politician, two mailmen, and the paper boy.

Door Traps

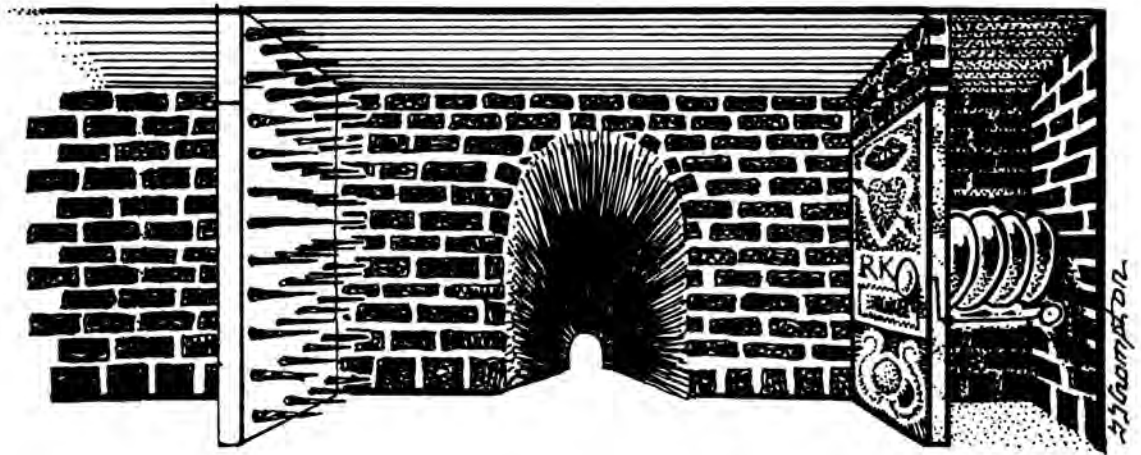

I open this chapter with the ever-devious Mark Bassett's **Double Trap**. This is one of those devices that just screams "Trap!!!" to anyone who sees it – but Mark puts this effect to amazingly good use.

On one side of a corridor is an ornately carved door; on the opposite wall is a heavy panel, also ornately carved, with lots of iron spikes attached. Apparently any attempt to incorrectly open the door will tenderize a delver – and numerous bloodstains in the area only serve to reinforce this suspicion.

However, the spikes don't move – the door does. In fact, the door is just a false front for an enormous spring which is set to slam the door across the corridor and into the wall of spikes. The spring is cocked at hair-trigger readiness, and the delver who monkeys with the door will be pulped before he can draw his last breath.

There *is* a door here, but it's a secret one. Where is it hidden? Why, behind the spikes, of course . . .



The **Sandman / Doorman** trap by Michael Austin opens up a new way of dealing with those characters who steal dungeon fixtures for treasure and deftly avoid the traps laid for them.

The door that is set up to be stolen is made of solid gold. Friezes of villagers doing normal peasant-type things are exquisitely sculpted upon the door's surface. Details, such as nostrils and mouths, are included and are vital to the trap. The value of such a door, either for the gold or for the sculpture, is incalculable.

The trap is within the hollow interior of the door. In the upper half of the door is packed great



quantities of a solid chemical that serves as one half of a knock-out gas. In the lower section of the door, there is a liquid that serves as the second half. In between the two halves are two glass doors that are hinged to open up towards the dry chemical. The doors have about a foot between themselves and the dry chemical or liquid when the door is upright. The glass doors touch and do not allow mixture of the two chemicals.

The trap should be obvious. If the door is battered upon, the glass will shatter and enough of the dry chemical will drop down to begin the manufacture of sleeping gas. The people attempting to batter the door down will become drowsy very fast. They will also destroy many of the sculptures.

If the door is removed from its hinges and set down gently, the liquid will seek its own level, knocking the lower of the glass doors down. The liquid flooding the upper chamber will produce lots of gas which will leak out through the sculpted nostrils. Any characters in the immediate area, lifting or lowering the door, should be overcome. I would imagine that their dreams might not be so pleasant.



Andy Beauchamp brings us **Spring Cleaver**, a door trap that could be sponsored by the prosthetics industry. This trap is a door with a sign hanging upon it which reads, "Open and Watch Me Spring Into Action." A spike protrudes a few inches out from the doorknob itself.

Turning the doorknob releases a spring which shoots the knob at the person who turned it. The spring is so powerful that the character holding the knob will probably lose his grip on it. At the same time, razor-sharp blades spring out from inside the knob, blossoming into a lethal cleaver. While this trap may not kill a character, it will certainly maim the person who trips it.



Shrieker Shrinker

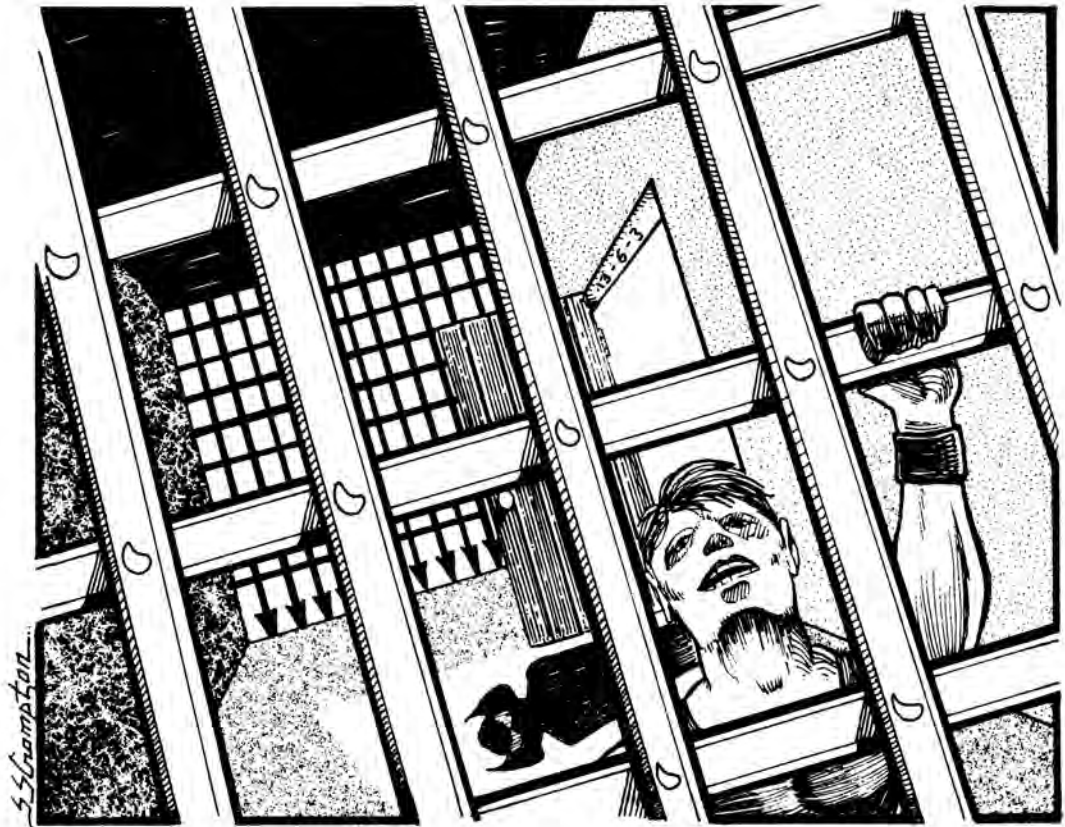

J. E. Todd contributes his **Shrieker Shrinker** to this chapter of traps. His door trap was designed to deal specifically with those delvers who like to open a door, take a quick peek into the room, and then slam the door and run away. If the monsters in your dungeon are tired of chasing after these peeping toms, you might install this trap for them.

This trap is activated by lifting the latch on a seemingly standard dungeon door. A hidden wire releases a portcullis from the ceiling on either side of the door, trapping the characters in a 10' × 10' section of corridor in front of the door.

If the delvers then walk through the door, nothing else happens. If, however, they attempt to raise a portcullis, they will release an 80-ton block of granite from the ceiling above their heads. Subtle, is it not?



The Catastrophic Keyhole is a door trap by Bruce Woodcock. It was designed to destroy the pesky lock-pickers that infest any dungeon-delving group.

This trap is hidden inside a standard dungeon door; there are no marks or unusual features to arouse a character's suspicions. But appearances can be deceiving – the door is actually a cleverly-designed bomb just waiting to be set off . . .

When a key or lockpick is inserted into the door's keyhole, a lever is tripped.

The Catastrophic Keyhole



The lever is actually a steel striker, which slides along a flint plate. One poke, or even two, might not cause a spark sufficient to touch off the specially prepared (and highly flammable – of course!) piece of cloth which is all around the strike-plate. But as the interloper continues to work the lockpick or the key that *seems* to fit, eventually a spark will catch on the cloth. (Guncotton is a suitable material: it catches a spark well, and burns just right). This cotton acts like a fuse, and burns down its length to the reservoir of gunpowder which fills the lower portion of the door. The resulting explosion should at the very least blind the character who set it off. It's far more probable that he'll be blown limb from limb. . .

What lies beyond this door of doom is up to you—but a blank expanse of brick wall is perhaps the most offensive sight, given the situation. . .

An even less subtle yet horrendous doom-bringer, is Greg Day's **2x4 Headache**. This is sure to be a slap in the face for any careless delver. . .

Simple in its construction, this trap merely consists of a spike-studded board which flops over into the doorway whenever the door is opened. If the delver is of normal (that usually means human) height, he receives a face full of spikes. If they are taller or shorter . . . well, you can use your own vivid imaginations to envision the possibilities!

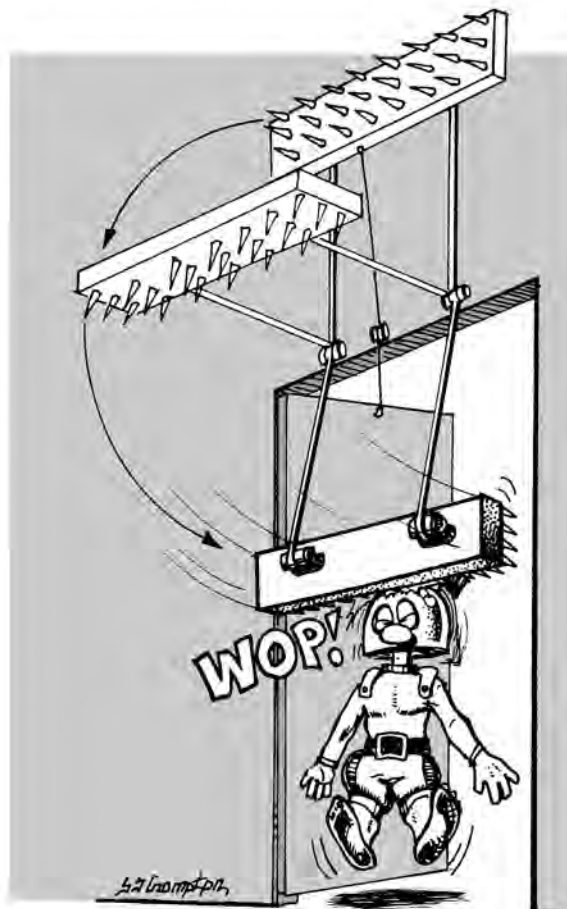



Door Traps

– NOTES –



What You Don't Know Will Hurt You is a revolving door trap from Brandon Corey (who is recovering quite nicely, thank you). This door trap is notable inasmuch as it sinks to new depths – or at least the delvers caught in it do.

The revolving door will only move in a clockwise direction; near the end of the door's rotation, the floor drops away into a pit. If a delver is running through the door with careless abandon, his own momentum will sweep him into the pit. And even if the delver should notice the pit in time to stop the door, he'll still be trapped – the door revolves only in one direction. He'll escape only if he can somehow make it across the pit . . .



Tired of adventurers finding your well-placed poison needle in the lock trap? Charles Manson was, so he designed the **Backstabber**, a splendid demonstration of overkill at its finest.

The delvers are presented with an innocuous-looking door. When the handle to the door is worked, the enormous, poisoned, sharpened telephone pole hidden in the wall opposite the door is fired toward the delver's back at tremendous speed. This ought to plaster the delver opening the door, and may take out a number of his buddies if they're standing close behind him. This pole is going fast enough to knock down the door, so don't use it to guard your teacup collection . . .

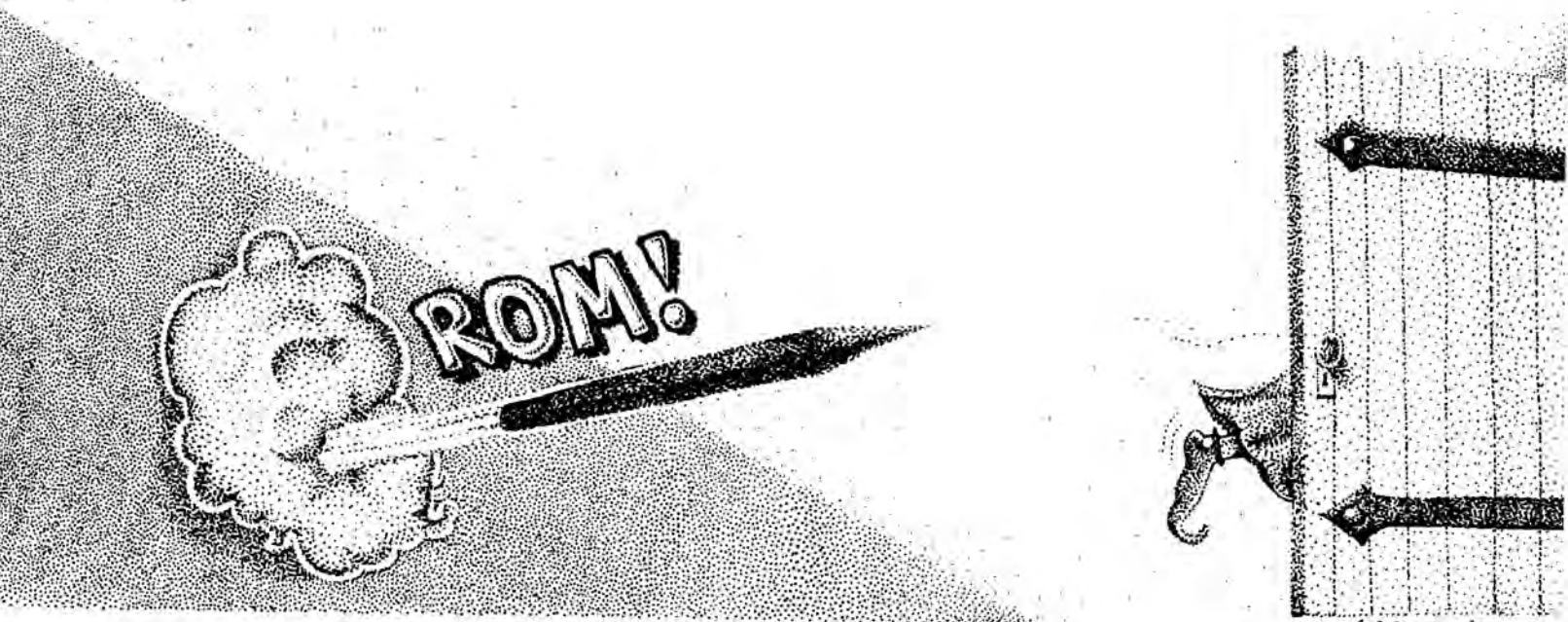

55 Crampston



If it's possible to go overboard with traps, then item traps are the easiest to overdo. Almost any item you can think of can become a trap – from a pair of boots to one's gauntlets, from ornamental armbands to a delver's trusty shield.

It pains me to say this – but go easy with these traps. As much as I enjoy watching delvers perish, it isn't as much fun when everything the party touches is a bomb waiting to explode. If you use too many item traps, your delvers will become paranoid nervous wrecks – and your dungeon trips will slow to a crawl.

Item Traps

24-3-44

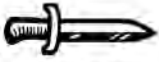

This chapter opens with a trilogy of oddball item traps for Pat Mueller, an avenging oddball in her own right. None of these traps are lethal, but each is sure to frustrate and annoy delvers . . .

First on my list is **They Cried With Their Boots On**, a normal-looking pair of knee-high leather boots that can easily be added to any monster's cache of treasure. The right boot has a built-in dagger sheath, complete with an elaborately

tooled dagger, which should make the boots attractive to almost any delver.

However, there's some strange magic in these boots. As long as no one is wearing them, the dagger can be pulled from its sheath. As soon as a delver puts the boots on his feet, though, the dagger won't come free for all the tugging in the world – and the character's hand is now stuck to the hilt of the dagger!

The magic is cancelled, freeing the dagger and hand alike, once the boots are removed. Inordinately clumsy characters should make fools out of themselves while trying to contort their way out of these boots with one hand stuck uselessly to their right ankle . . . especially if they're trying to fight at the same time . . .



Metal armbands have been all the rage since fantasy artists started clamping them on the naked biceps of their barbarian heroes. I have always considered them quite useless. After all, they are pitifully small to be armor, and nothing can help the looks of barbarians. Simple things amuse simple minds. A delver ought to leap at the

chance to own a pair – and, hence, Pat's next deceptively subtle trap: **Magnetic Arm Bands**.

Should a delver slip on these ornate armbands, they will build up a biomagnetic charge within about five minutes. They'll clamp together – *ka-chang* – and will be very difficult to pull apart. If these armbands are donned by an especially wimpy would-be barbarian, the attraction of the bands might lead to dislocated shoulders.

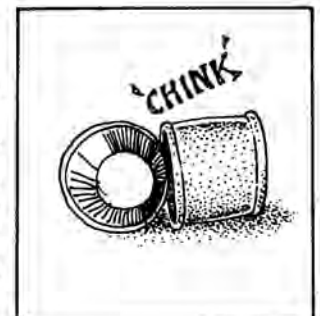



Pat's last trap is the **Slime Gauntlet**, which is sure to amuse idiots for hours and hours.

The trap is a magic gauntlet which, if it touches any loose gemstones, transforms them into an inanimate slime of the same color. The slime is useless, but functions admirably as a toy for the feeble-minded . . .

Similar to the *Slime Gauntlet* in feel but different in effect is Larry DiTillio's **Glue-Gems**. These are odd-looking jewels, colored something like rubies and emeralds, that are always found in an airtight container. In reality, the gems are a weird form of "super glue"; when exposed to open air, they steadily melt into a gluey, gelatinous gook.

The delver who casually dumps these gems into his pack or pouch – or pocket – is in for a big surprise. Once melted, the gems cannot be reformed, and everything they come in contact with is permanently stuck together (sort of like peanut brittle). These gems can be especially nasty if they're deposited into a sack containing a mage's favorite scrolls or spellbook.

If you're kind-hearted (fie!), you can create some sort of solvent to unstick the mess.

Torches always make good item traps, and the **Ole Smokey Torch** by Larry DiTillio is no exception. This torch looks like an ordinary firebrand in appearance. When it burns halfway down, however, the flame touches off a concentration of noxious chemicals which causes thick black smoke to pour out and engulf the

torch-holder and anyone near him. If nothing else, this should prove rather inconvenient for the party.

James Brazier brings us the **Scold's Bridle**, a must for loudmouths in the dungeon party. It works especially well on egomaniacs with swollen heads.

This trap appears to be a heavily jewelled crown of great worth. With any luck, the loudmouth of your dungeon party will claim

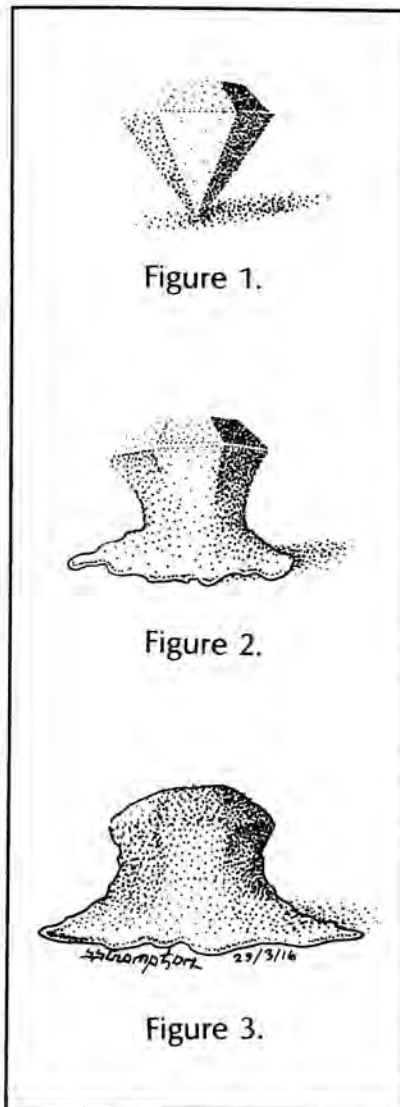
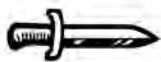

Figure 1.

Figure 2.

Figure 3.





Item Traps

– NOTES –

this pretty bauble for his very own; he'll probably even try it on. As soon as this crown is upon a character's head, however, it shrinks to an uncomfortable fit and cannot be removed.

Every time the crowned character attempts to unfairly boss the party around, the crown will tighten slightly. Eventually it will crush his skull, but should cause blackouts and brain damage first. And perhaps the rest of the party will take the opportunity presented by the loudmouth's condition to remove his head for the crown atop it . . .

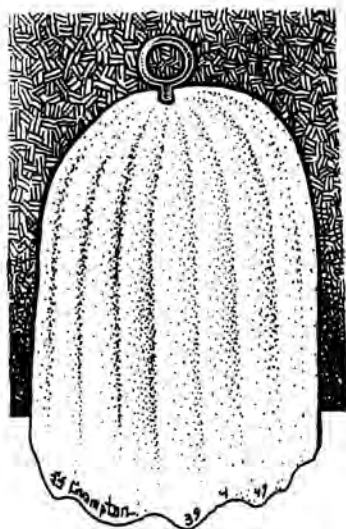

For Someone Special is an elegantly simple item trap by Caroline J. Maher. This trap is sure to be a killer, so make sure you save it for the most special of targets.

This Trap is a parrot cage draped in a silk cover. You can ornament the cover with whatever sentiments you choose. Clear the room before someone removes the cover, however – for within lurks a basilisk!



When not displaying his talent with a brush or pen, Steve Crompton is a fiend in his own right. His second contribution to this year's trap book comes in the form of the **Gallium Grapple**, a trap as cold and

cruel as the environment needed to make it work.

Hidden at the base of a huge, icy cliff where the temperature is well below zero, the adventurers find a padded grappling hook with a length of rope attached to it. At the top of the cliff, something is glowing, and strong, beneficent magic can be sensed.

Using the grappling hook and rope to ascend will take four casts of the hook. The final cast will hook the top of the cliff. Here is where the trap is sprung because the hook that has held on for the other three times will now fail. Gallium has a low melting point, and the magic on the cliff top causes everything to warm up to 100° F within thirty seconds of landing there. That should be enough time for a character to be in mid-climb before the hook melts and goes away. It works as a costly experiment in practical chemistry.

Liz Danforth and Mike Stackpole offer a quick and simple trap designed to have players tearing their hair out in frustration, or something to the same effect. **Excalber Reprise** begins

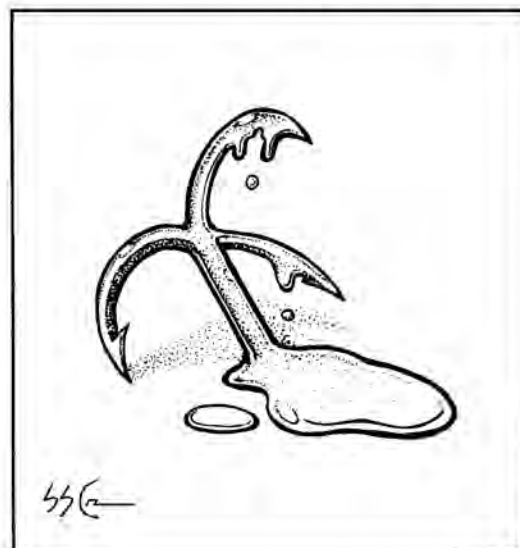



Excaliber Reprise



when the characters discover a huge boulder in the dungeon. Sunk up to the hilt in the boulder is a sword. The hilt is black and large enough for two hands. When the sword is pulled from the stone, and it should take some strength to do so, the adventurer finds he now owns a five-foot long black broadsword with glowing runes worked up and down the blade. The runes are strange, one of them consisting of three megaphones within a circle, the smaller end of each pointing at a dot in the middle of the circle. The runes, when translated – and it should take a long time to do so – will read “Property of the Nuclear Regulatory Agency.” The runes glow without magic, you see, and when a character’s hair begins

to fall out, and other signs of radiation sickness begin to show themselves, translating the runes will be the least of the character’s worries. One should never go pulling irradiated swords from their lead-lined boulder sheaths. . .

The following item trap was designed by Scot Rhoads; it is a weapon with a twist, and should lead to any delver’s undoing.

The **Swiss Army Sword** looks deceptively normal. However, the hilt of this sword is another case entirely – it is split such that the sword blade can pass freely between the halves. One good whack in combat, and the tang will break free from its rear supports, causing the sword to pivot back through the hilt on one pin. If you sharpen the tang as well, you can relieve the delver of any extra fingers . . .

Most treasure comes in the form of loose coinage, so it only seems natural that coins should be trapped somehow. The following two traps describe ways this can be accomplished. While neither trap is “dangerous,” each insures that the coins they protect won’t be had without paying a price.

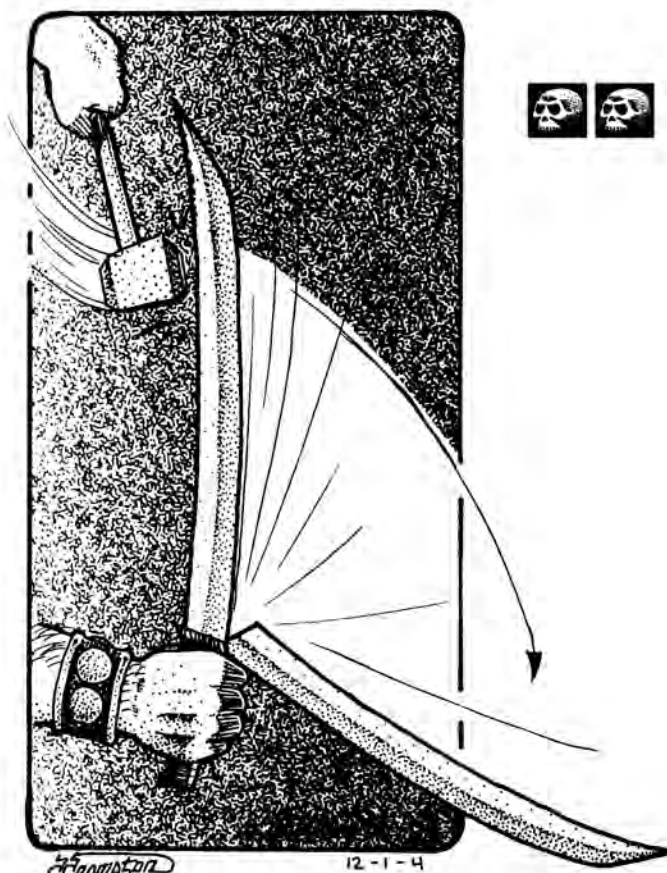

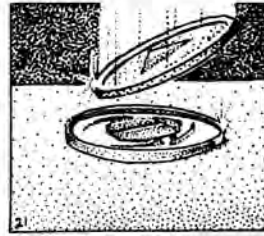
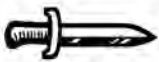

Figure 1.

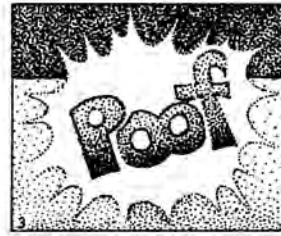

Figure 2.

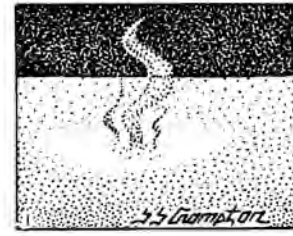

Figure 3.



The coins in Liz Danforth's **Funny Money Trap** are magical, and work best when found apart from some massive treasure. Whenever one of these coins comes into contact with a normal coin, both disappear.

Most characters just dump loot into their packs – to do so with *Funny Money* means they'll end up with less than they started out with. Effective use of this trap requires you to keep track of how much money your characters keep where, but I think you'll find the frustrated responses of your delvers to be well worth the effort.



John Strain's **The Heavy Coins Trap** uses real money, but is no less frustrating. A thin, transparent coating has been applied to the coins of any hoard; this coating causes the coins to weigh about half again as much as they should. A delver who picks up a single coin

probably won't be able to feel the difference. However, when he dumps the hoard into his pack, he'll probably stagger under the increased load.

You'll have to decide how the coating could be removed. Intense heat or a sharp blow might do the trick.



Larry DiTillio has come through for me again with a weapon trap that spares nothing to provide the utmost in discomfort for delvers.

The "Don't Sweat It" Polearm trap is a nifty-looking pole-arm, embellished with a magical glow for effect. Its bearer will find that it functions just like any normal pole arm . . . with just one catch.

The haft of this two-handed weapon has been liberally coated with a super-adhesive that is activated by sweat. Unless he wears gauntlets of one type or another, a person using this weapon will find that his hands are glued to it! The pole-arm is indestructible, so our hapless delver has a new quest: the search for the proper type of solvent.

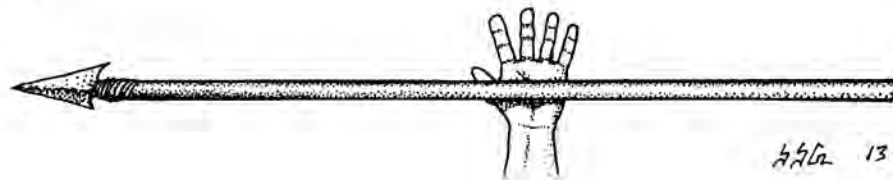

hsl 13-4-29

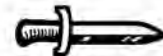

The next two item traps were designed by Bucky Hernandez, my favorite dungeon master from south of the border.

First is the **Matchless Shield**, a fine wooden shield decorated with a boss of set stone. Unbeknownst to the lucky finder of this shield, however, the stone portion is flint, and the wood has been impregnated with a flammable oil. A careful inspection will probably reveal these anomalies – but whoever said that a treasure-grabbing delver is always careful?

The shield will hold up quite well in combat – until it is used against a foe with steel weapons. Then, any shot taken on the flint boss will strike a fat spark – which will ignite the shield! The shield will burn in a most spectacular manner, as will the delver's arm . . .



The End of Your Rope takes the form of a heavy length of coiled rope with a grappling hook attached. While the rope appears to be normal hemp, there is, in fact, much more to it than meets the eye.

The entire rope is woven around a long fuse. Attached to this fuse at the rope's midpoint is a small, airtight vial filled with a volatile chemical compound. When the rope is stretched (something that happens when it is used to climb something, or to pull a person out of a pit), the vial opens and the chemical hits the fuse. The rope smolders for about a minute before burning up all at once from the inside out. This could cause a bit of a panic if the rope is being used to scale a cliff . . .

Of course, if the delvers cut the rope open, they'll discover its true nature – but who's going to think of that?

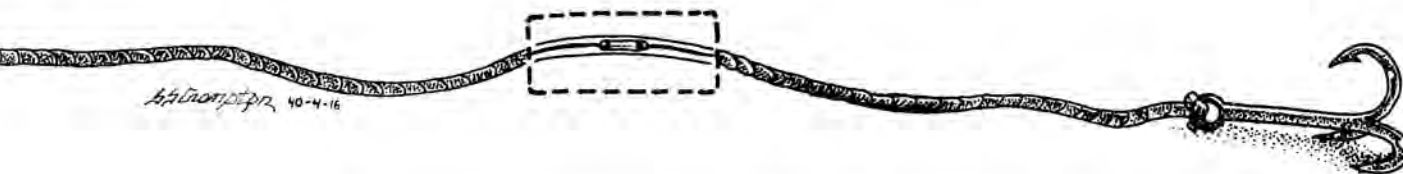

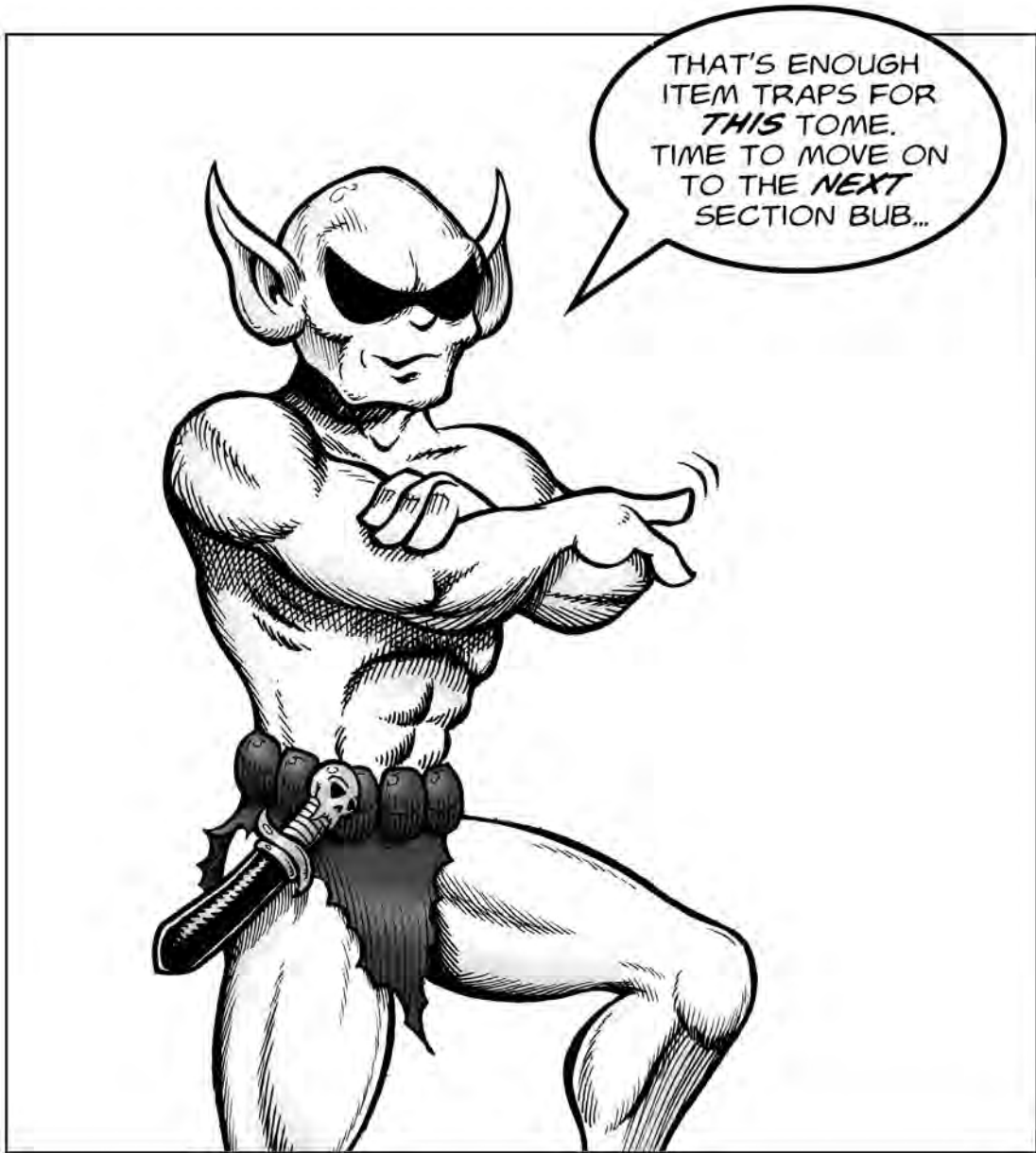
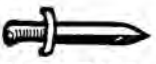

VOU

55 Crampton

CAK:



As usual, I have a number of traps that just won't fit neatly into a category. They're not rooms, or corridors, or doors, and can't be stuffed into a delver's knapsack. However, they will burn, maim, squash, bloat, and generally annoy almost anyone.

Things can come in almost any form – but when you get right down to it, “deadly” is the shape of the things to come . . .

Things



My first two “thing” traps were created by Mark Bassett. If you combine both traps, you could flypaper a delver to the floor while roasting the flesh from his bones. Good sport, what?



The **Epoxy Trap** is to be found in a corridor that is covered with foul-smelling, oily puddles. One puddle will coat the feet or boots of anyone who sashes through it with a gooey substance. If the delver doesn’t pause to clean his feet, but immediately steps into the next puddle, he completes the application of epoxy – and finds himself stuck to the floor. The epoxy quickly hardens, and no human can pry it loose. The epoxy can only be removed through tedious picking with a sharp knife, or through the application of the proper solvent.



Once your victims are stuck to the floor, try springing the **Napalm Rocks** trap on them. The “rocks” are actually rare root bladders found in the lairs of snollygosters; the roots store food in the form of a jellied fatty oil that is highly flammable.

Attach several of these roots to the ceiling of your dungeon. They’ll be inconspicuous until someone touches a torch to them – which will burst the skin of the root and shower flaming oil onto the delver below. To be fair, the delvers might actually notice the oddly shaped and colored lumps in the ceiling, and recognize the abnormality before they get fried . . .



Jonathan Bernick’s sinister brand of trap construction oozed forth again in **Genius Gold**, and this gives us perhaps a glimpse of how Jonathan comes up with his diabolical devices.

In a chest, or a sack or pile, adventurers find gold coins that look fairly normal. The unusual feature to these coins, on the surface at least, is that instead of having a face or profile stamped upon them, they bear a representation of a brain. They stack, feel, smell, and taste like gold, but despite the glitter, gold they are not.

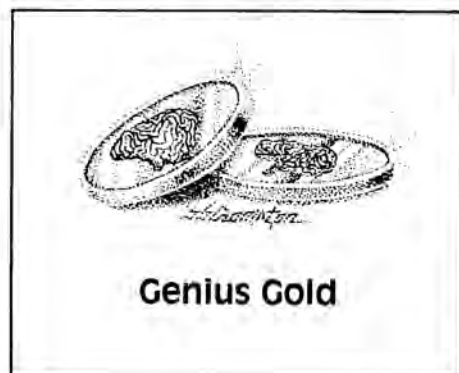

Genius Gold

Each of the coins is a piece of a hive mind. The more a delver gathers, the more powerful the mind he is transporting gets. The coins begin to use the delver like a horse to get the delver to transport them where they wish to go. They subtly take control of the delver’s mind. They influence his choices by adding illusory, auditory, and other clues. From one



passage, the adventurer might possibly hear the laughter of women and children playing, or think he smells fresh air, while another passage looks dark, dingy, and smells of brimstone.

When the mind has gotten where it wants to be, it will probably make the delver believe there is something to spend his money on or a fountain to wish upon before him. Once he has thrown the mind away, the delver will be sent off. The mind will wait . . . until the next time.

Tired of delvers burning up your giant spiders? These next three traps are sure to put some new life into the old cliché of torching spiders in their lairs.

The first is the **Spiderweb Fuse Trap**, by Bucky Hernandez. This trap is sure to re-educate those anti-arachnid types who delight in burning up the homes of poor innocent spiders.

The trap takes the form of a room apparently filled with spiderwebs. For effect, include a clever mock-up of a large nasty spider. When the delvers set their torches to the webs for kicks, they'll find that they have just ignited an interlocking series of fast-burning fuses! The fuses are connected to kegs of oil or black powder in the walls of the room. When the flames touch off the kegs, the resulting explosion will either fill the room with flaming oil, or bring the ceiling and walls crashing down in a thunderous explosion on top of the callous home-wreckers! Bammo – delver quiche!





The next trap in this trilogy of spider-savers is the **Miss Moffat Engine of Destruction**, designed by Michael Austin. Its construction is simple and elegant — and its effect is ghastly.

The central feature of the trap is a large bronze sphere. Inserted into opposite sides of the sphere are two L-shaped pipes which point in opposite directions. The device is similar to Hero's steam engine — except that the globe is filled with a flammable liquid instead of water.

The sphere is camouflaged until it looks like the abdomen of a large spider. Legs and a forebody are added by using clay, paper mache, or any other acceptable material. The spider is then placed in the center of the floor, in an area relatively free of obstructions. To heighten the effect, add spiderwebs.

If the delvers hit the “spider” with a torch, the sphere will ignite. The L-shaped jets will cause the sphere to spin madly about on the floor, spewing flaming liquid throughout the room and onto the party.

As the final horror, consider combining this mocked-up spider with the *Spiderweb Fuse Trap* described above. Now you're talking about mayhem . . .

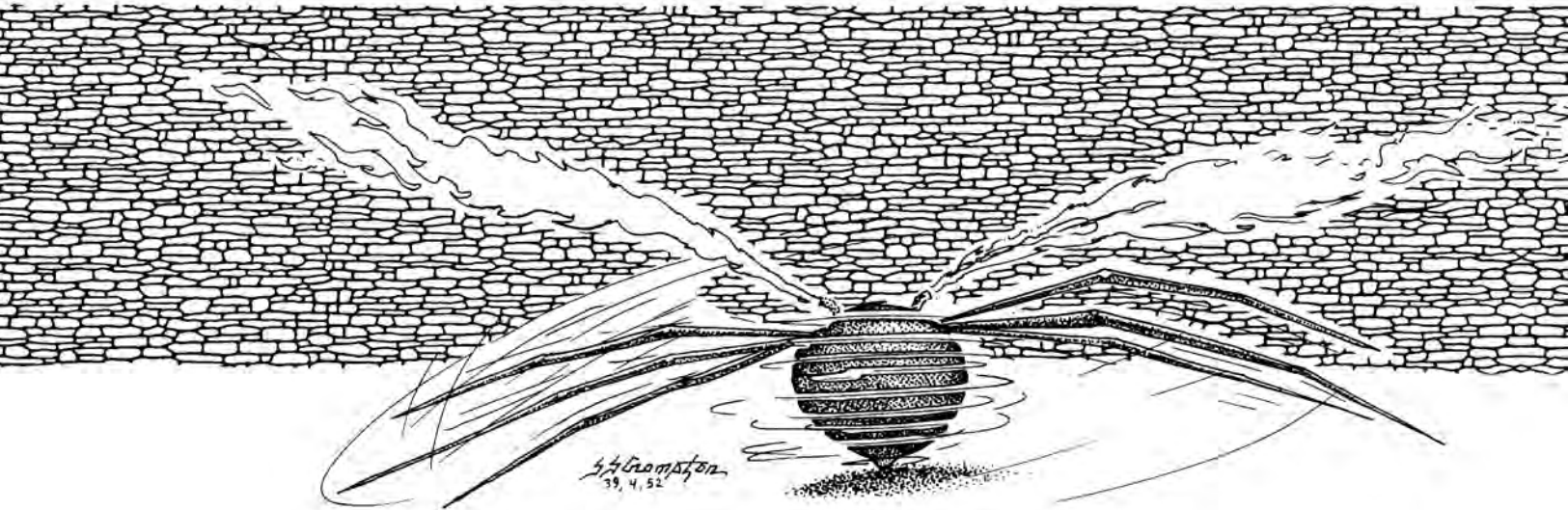

Our last “spider trap” is the **Black Widow Piñata** by Larry DiTillio and Paul O'Connor. This trap is designed to reward quick action.

Opening the door to this room trips a hidden catch, which silently releases what looks like a huge black widow spider. The spider hurtles down towards the door on a web line. If the delvers rush forward and slash open the spider with their weapons, they'll find that the spider is really just a hollow papier maché mock-up — and is filled with thousands of live, normal-sized black widow spiders which now scatter onto the party. Olé!!



Steve Crompton's **Hellevator** is a trap which capitalizes on the propensity of a delver to lock himself into a box and then try to punch his way out. The adventurers find an elevator, though to them it would have to be explained as a room that moved from one level of a dungeon to another. The elevator is air-tight and operates on a simple cable and pulley system operated from above. Occasionally, however, the elevator gets stuck between floors.

Filling the elevator shaft is chlorine gas. It's not odorless, it's not colorless; it is extremely hard on the respiratory system of those foolish enough to inhale it. Since the elevator is air-tight, the delvers will not find out about the chlorine until they breach the top or sides of the elevator when it gets stuck. Having a magically produced voice urge "Please stay where you are; help will arrive within the hour" is one sure way to get the delvers to crack the elevator in an effort to escape. After all, if you had just looted someone's treasure chambers, you definitely would not want to meet anyone who is most likely to come to your aid.

This next oddball "thing" was developed by Chris Weitz. To work, it relies upon misconception and the never-failing ability of delvers to take things at face value.

A party of delvers might find **The Trojan Dragon** anywhere in your dungeon – but if they encounter it in a deep chamber filled with treasure, the effect will be heightened.

The "dragon" isn't a dragon at all, but rather a balsa wood mock-up that looks very much like the real thing. Any weapons used against this contraption will lodge in its "skin." As anyone who has made model airplanes knows, blades are difficult to remove from balsa wood.

Lurking in the hollow "stomach" of the dragon are a number of rather intelligent monsters. When they hear the sounds of delvers hewing into the dragon, they'll rush out through the thin skin of the mock-up and engage the characters in combat.

Of course, setting fire to the dragon will make things uncomfortable for the monsters hidden inside. But what delver in his right mind would hurl a torch at a sleeping dragon?

Stefan Jones, a first-class "thing" trap in his own right, has sent in two traps for this chapter. The first is called **Crossed Swords** – although "crossed wires" might be a more appropriate title.

Hanging over a cheerfully burning fireplace are a pair of



34-0-21

470-63



beautiful swords. The jewels in the hilts are obviously real, and the swords themselves would make an admirable prize.

If the swords are pulled off the wall, however, a sack of tightly-packed gunpowder hidden behind the wall is released. The sack falls into the fire, and . . . well, the delver who grabbed the swords won't have much need for them anymore.



Water That Glimmers, Shimmers, and Kills is David Steven Moskowitz's entry to the "thing" trap derby. This trap is simply a waterfall of living diamond, which should look like nothing more than a beautiful sparkling waterfall.

Everyone knows that the hardest substance around is the diamond – and when its razor-thin and falling, it will cut through almost anything. Pity then the delver who sticks his hand through this waterfall, or tries to gain entry to the cave beyond . . .



The **Paranoid Frustrator** is a magical effect presented to us by William Toivainen. This trap is more fun than dressing up like an old woman to frustrate do-gooder boy scouts.

This nefarious and sneaky trap is dependent on a magical spell which is centered on a chest or another item of dungeon decor that is attractive to adventurers – but usually the hiding place of some nasty trap. The paranoid delver (and we have all seen the type), will certainly open the chest or touch the item with something as long as the proverbial "ten-foot pole." When this happens, the magic is triggered, and the effect centers on whatever is touching the chest. In this case, the delver will become the owner of a ten-foot pole that has received a noticeable boost in the apparent quality of its appearance. Evidently, had a character touched this chest, he would have received a bonus to his charisma, or some equivalent attribute. The character will probably pick up a desire to touch the next chest he comes across. If there are several such things presenting in apparent "sequence," the delver will almost certainly be seduced into a close encounter of the worst kind with the next chest he sees, and that is the best part of the trap.

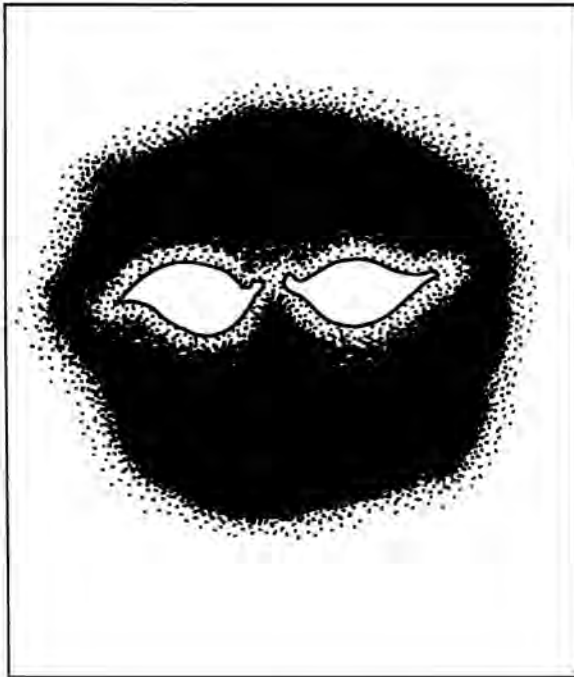

The Eyes Have It is an interesting nuisance trap by Steve McAllister. It can be put almost anywhere in your dungeon, although a corridor with a high ceiling is perhaps the ideal location.

The delvers will see two large luminous eyes peering out at them from the darkness down the corridor, some distance above the floor. If you play this right, you can frighten the party into wasting missiles and magic on the imagined horror before them. To the party's eventual chagrin, they will find that the eyes are only a clever illusion painted upon bare stone with luminous paint . . .



Equally unsettling is the **Fireman's Pole** by Steve Jackson. This trap takes the form of a simple brass fireman's pole which is bolted to the ceiling and disappears into darkness through a hole in the floor. When delvers jump onto the pole to slide down, they are in for a nasty surprise or two . . .

The most cost-effective thing to do is to end the pole several feet above the floor of the room below (assuming, of course, that the room actually has a floor). Depending on how far you want them to fall, the delvers could really be in sad shape after they land . . .

A more bizarre possibility is to construct the last ten feet or so of the pole out of an elastic substance, and still have it end several feet above the floor. Thus, when a sliding delver reaches the elastic, the pole will stretch under his weight (and *might* touch the floor). It's likely that the pole will stretch for a given distance and then snap back like a rubber band, flinging the character into the ceiling!

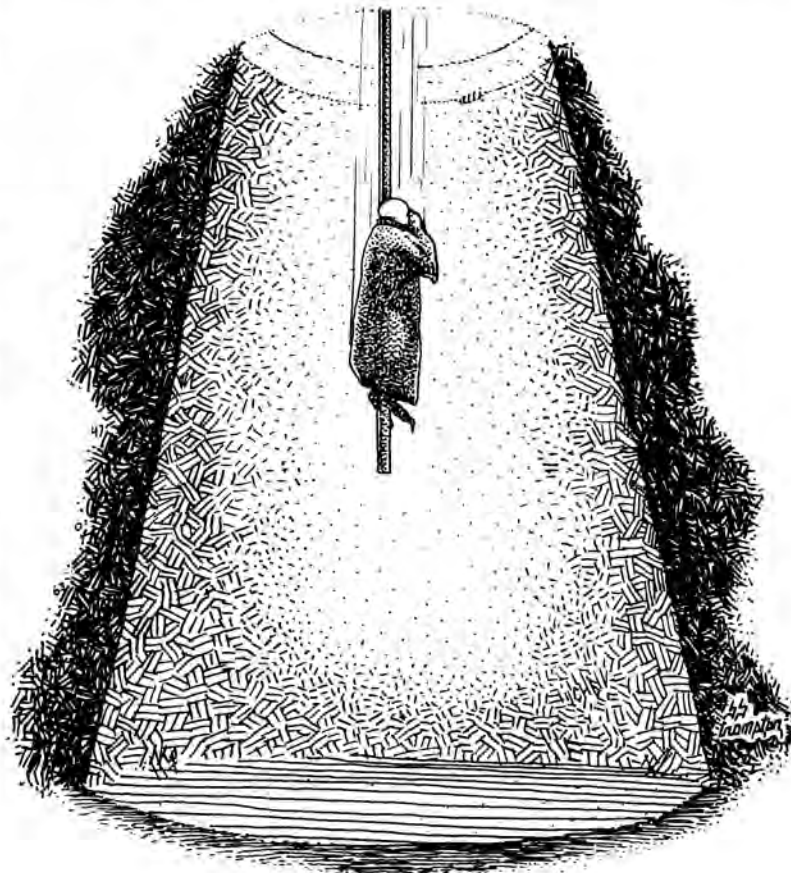

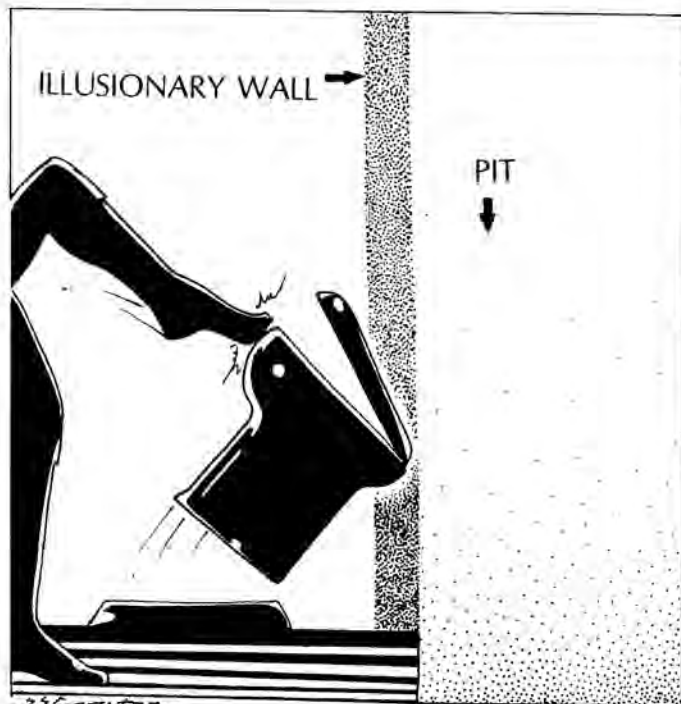

Stefan Jones' **Tumble Toidee** appears to be an ordinary privy which is extraordinarily clean (which may be a tip-off for worldly delvers). No amount of thumping on the seat will trigger crossbows, trap doors, or alarms. There is nothing hidden under the privy seat; there is nothing concealed beneath the privy; and there are no invisible weights suspended over the room.

When someone sits on the seat, however, and places his feet on the foot-rest, the whole assembly will be free to rotate backwards through the illusory wall behind it, to tumble its occupant into the shaft below. This trap is sure to catch delvers with their pants down . . .



Fibber McGee's Closet of Caltrops is a nasty addition to my book by Bob Greenwade. While most people will understand what happens from the title, a bit of an education in classic radio for those who don't understand is in order. Once upon a time, there was a man named McGee who had a closet jammed full of everything in the world. Whenever someone opened the door . . . CRASH! And none of those things were as soft and cuddly as caltrops.



Delvers are always looking for trouble – and they'll certainly find some here with **The First Sign of Danger**, by Rick Loomis. On a stone dungeon wall is a sign reading "DANGER!", with a few lines of smaller print below the main lettering. The fine print cannot be read from afar, but when someone leans close to the sign to see what it says, a powerful spring rams the sign itself into the character's face. This sign is printed on a block of stone, so the danger here should be quite evident.



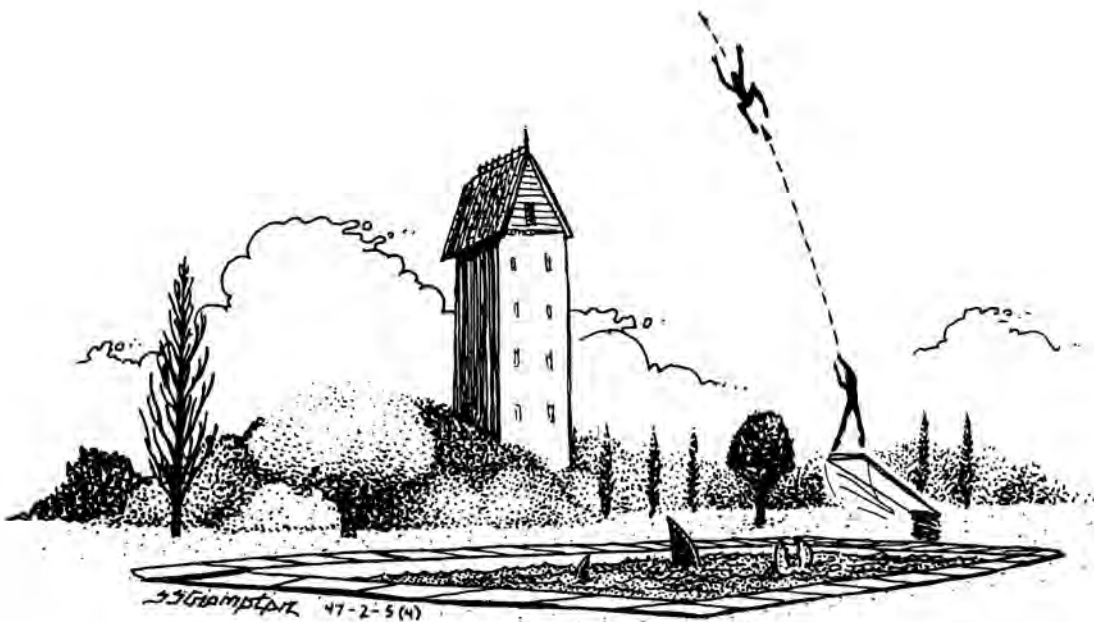

Ken St. Andre is to blame for this next “thing” trap, titled **Leaping Wizards**. The trap resembles a modern swimming pool with a few major modifications. It can be located either indoors or outdoors – whatever suits your fancy.

A suitably enticing treasure is scattered about on the bottom of the pool in such a way that it will prove impossible to net or drag it out without entering the water. Anyone who tests the water will find it to be incredibly briny. Every now and then, something black and awful will surface (fill this pool with a variety of toothy aquatic horrors that most delvers wouldn't want to tangle with . . .).

At the deep end of the pool is a diving board; on the board, in red non-skid letters, is painted this inscription: “Whoso diveth from this board is safe from the Dangers of the Pool.”

The real trap here is actually the diving board, which is sturdy and springy and radiates functional magic. Anyone who leaps from the board, no matter how gently, only goes up! The character won't come back down unless the magic of the diving board is somehow negated. For those of you who insist upon a rule for everything, the character's upward speed is equal to the acceleration of gravity, $D = 32t^2$ where D stands for distance and t is time in seconds.

If this trap has been placed outdoors, a character who dives off the board may find himself bidding farewell to the planet of his birth. If this is an indoor pool, then the “diver” will probably smash into the ceiling (taking damage proportional to the distance traveled). Last one into the stratosphere is a rotten egg!



The Accordion Throne is a weight-loss device by Pat Mueller that should make the bench press obsolete. It's a high-backed marble throne, ornately carved and decorated, which ought to nicely fill a vacant corner in your tomb complex.

When some egocentric delver-who-would-be-king seats himself upon the throne, the arms neatly fold together like a monstrous beach chair, making the delver extremely slim in a matter of seconds. No fad diets! No medication!



Taking his inspiration from an old Indian monkey-trap, Larry DiTillio designed **The Blotomoto Trap**. It won't draw blood – but it should hamper any delver stupid enough to fall for it.

This isn't really a trap at all; rather, it's a contact poison which causes any living tissue it touches to swell up to five times normal size. The effect isn't permanent, but you'll have to decide how long it will last.

A large gem of great worth has been dusted with this chemical, and then was dropped into an indestructible vase made of some clear material. A delver who reaches into the vase to grab the gem will find that he can't get his hand out! If the character was smart enough to shake the gem out onto the palm of his hand, his hand won't be trapped – but he won't be able to use that hand for anything for a while . . .

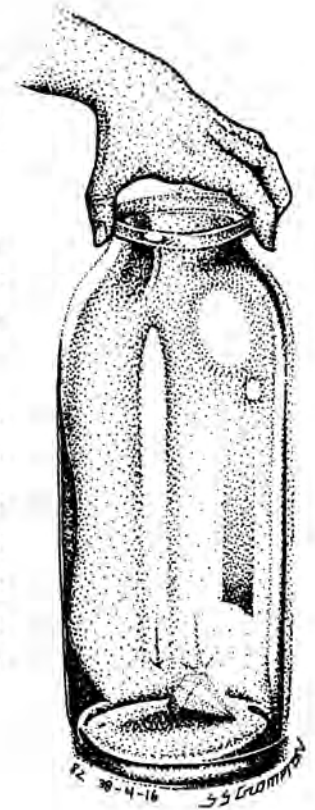

Matt Scholl doesn't sound like an Egyptian name, but this **Rigged Mummy** is dedicated to the memory of such devious architects as designed the depths of the Great Pyramid and other ancient deathtraps. This trap is another answer to the truly ancient question of how one can deal appropriately with those foul adventurers who feel no remorse at the destruction of the bodily remains of someone's favored ancestor. The usual response of these heartless blackguards is to torch the resin-soaked remains, resulting in an inpromptu cremation. While it may not be possible to protect one's predecesors from the effects of flame, it *is* possible to wreck havoc among those destructive incendiarists who fire off their enthusiasms by torching a mummy booby-trapped like this. The favored pharoah would surely appreciate the irony – and most certainly won't object to taking revenge posthumously on those who destroy him. Hidden under the wrappings, below the unbeating heart, rests a keg of gunpowder: the conflagration which results should daunt the survivors, if there are any (which is unlikely, at best).

So there you go - 100 more of my traps. Use them wisely. What's that? This book is supposed to have 101?

Very well. Remember you asked for it...

The 101st Trap



101st Trap
– NOTES –



Again, again I find that my task here has drawn to an end. Wearisome as is the work of reading and evaluating the offerings from pitifully human minds, I take a small delight in finding some humans truly do have the talents to live up to the evil reputations passed on by my smaller kith and kin – the orcs, gremlins, ogres and the rest. They speak of such terrors inflicted at the hands of humans, one would imagine a species more troll-like – how droll!

I do take pride in the tales I have heard of the malevolent gigglings caused by reading my first book of traps. And I anticipate much more of the same with this collection of cretin crushers. I also anticipate the reaction of many of you who read my first primer of peasant pacifiers. Even now I can feel your gloved fingers fumbling with the pages. You seek to take any precaution, no matter how feeble or futile, to protect yourselves against my destructive abilities. Come now, you flatter yourselves. I have killed kings, maimed maharajas, eviscerated emperors and diced druids. Do you honestly, in your heart of hearts, believe you could stop me?

I thought not. Relax; remove the gloves. I need not stoop to repetition. I have other ways.

For the trap I present here I went to great length; others went to great pains. I knew what I wanted for an effect, yet I was quite at a loss for a means to accomplish my end. On the suggestion of several companions (may they rest in peace), I distilled various bodily fluids from noxious creatures that crawl and slither in places best left unmentioned. Then I ventured across tall frigid mountains cloaked in blizzards to jungle basins flooded with insects, disease and pesky natives. Always what I sought eluded me.

Then my studies turned to the paths of sorcery. Late hours and priceless



101st Trap

- NOTES -

sacrifices went unrewarded as I strove mightily to pierce the veil of chaos that surrounded my subject. Even when I discovered new facts, new formulae to help me with other works, I was frustrated in my primary search.

Daunted though I was, defeated I was not. While your kind may struggle against adversity, I take it by storm. I combined my studies, taking samples from my multi-world travels and subjecting them to eldritch witcheries. And in this I succeeded, even beyond my wildest dreams.

You see, my task was once again to visit a suitable form of retribution upon those who ransack my libraries. Now that it is known that I protect my books, they are stolen unread; others destroy my precious volumes in an attempt to rob me of information. (Indeed, an attempt of that sort interrupted my studies, though it was dealt with effectively enough). Also, I found a large number of individuals using my books while wearing gloves, or developing baths to wash away my "fixative."

What I sought was a bit more . . . active. They would travel to the inquisitive louts, arriving when they least expect it. They would attack the bumpkins at their own leisure, slowly, carefully, and quite thoroughly. Before the vile blackguards even knew what happened, it would be too late.

Encoded in the cypher below I offer you my 101st trap. Break the code and you'll have the trap – but not before the trap has you! (Besides, it'll be good practice for later – if you survive long enough).

0:|A C |° ⊕ v:|Δ |:|N Δ° ⊕ |:|N ⊕ |:|A
 0:|U |° A ⊕ |° Δ° C O C O N C O |° |:| |:|:|:|:|°
 v O ⊕ N C : Δ° C ⊕ A C N |:|:|A C O U N ⊕
 N A ⊕ |° v |:|N Δ° ⊕ O N |:|C O O |° N |° ⊕
 |:|C N O |:| Δ° ⊕ |:|N ⊕ |:|A ⊕ |° |:|A ⊕ O N |° N :
 |:|: |:|C Δ° C O U N ⊕ O |° Δ° v O ⊕ N C
 v O ⊕ N |:|A A N ⊕ C |:|v |:|A Δ° |:|O v A v
 |° ⊕ |° : |° v |° N N O v Δ O U C A N ⊕ C O |°
 Δ |° N A ⊕ |° N O v |:|A Δ |° |:|O N |:|C O C O C O |:|C
 ⊕ O ⊕ |:|° C O N |:|O v O U : v |:|N v O U
 |:|A C |:| |° N O |° C |:| |:|: : Δ |° v v |:|:|:| C |° O |:|N |°:
 0:|A C A N |:| ⊕ O |° A N C

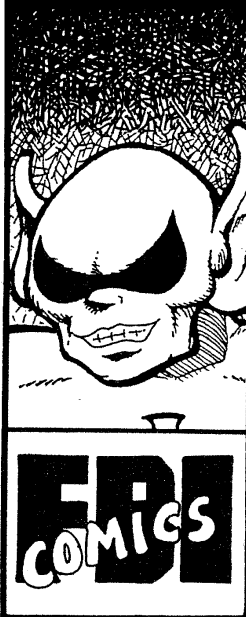
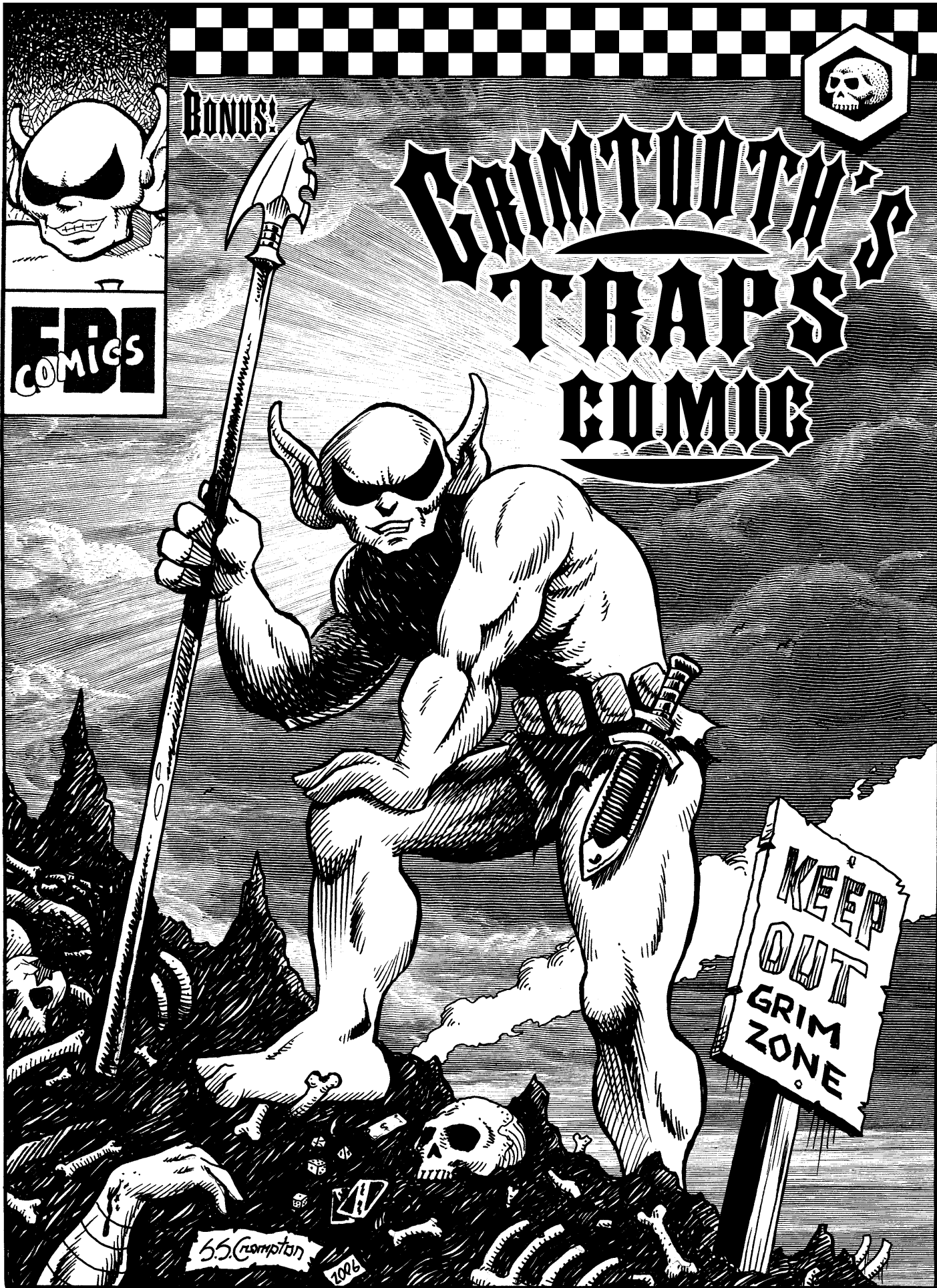

BONUS!

GRIMTOOTH'S TRAPS & TRAPS BUNDLE

KEEP OUT GRIM ZONE

S.S. Compton 2006

A DAY AT GRIMTOOTH'S

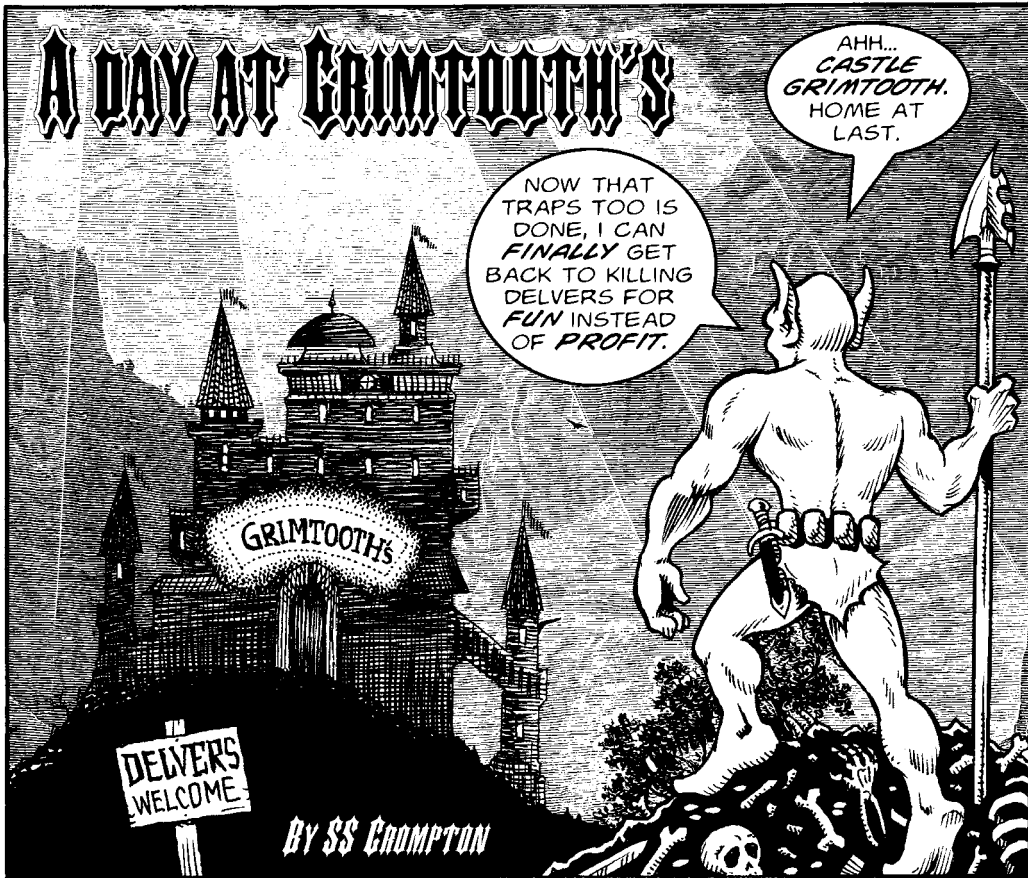

NOW THAT TRAPS TOO IS DONE, I CAN FINALLY GET BACK TO KILLING DELVERS FOR FUN INSTEAD OF PROFIT.

AHH... CASTLE GRIMTOOTH. HOME AT LAST.



HAH! I WONDER HOW MANY FOOLS HAVE DIED SEARCHING THE CASTLE? MY TREASURES ARE DEEP BELOW, OUT OF THEIR REACH!



SPIKE!
SO YOU'VE COME TO GREET YOUR MASTER HAVE YOU? ARE YOU BURYING THAT, OR DIGGING IT UP?

ARF!

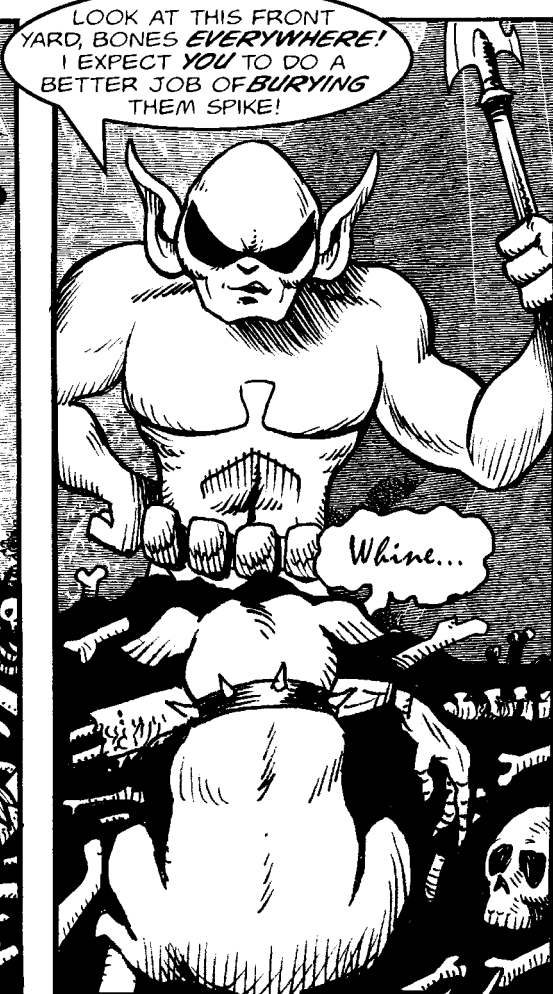

LOOK AT THIS FRONT YARD, BONES EVERYWHERE! I EXPECT YOU TO DO A BETTER JOB OF BURYING THEM SPIKE!

Whine...



ALL THESE BODY PARTS MIGHT SCARE AWAY POTENTIAL SUCKERS - I MEAN DELVERS. C'MON LET'S GO IN...

ARF!

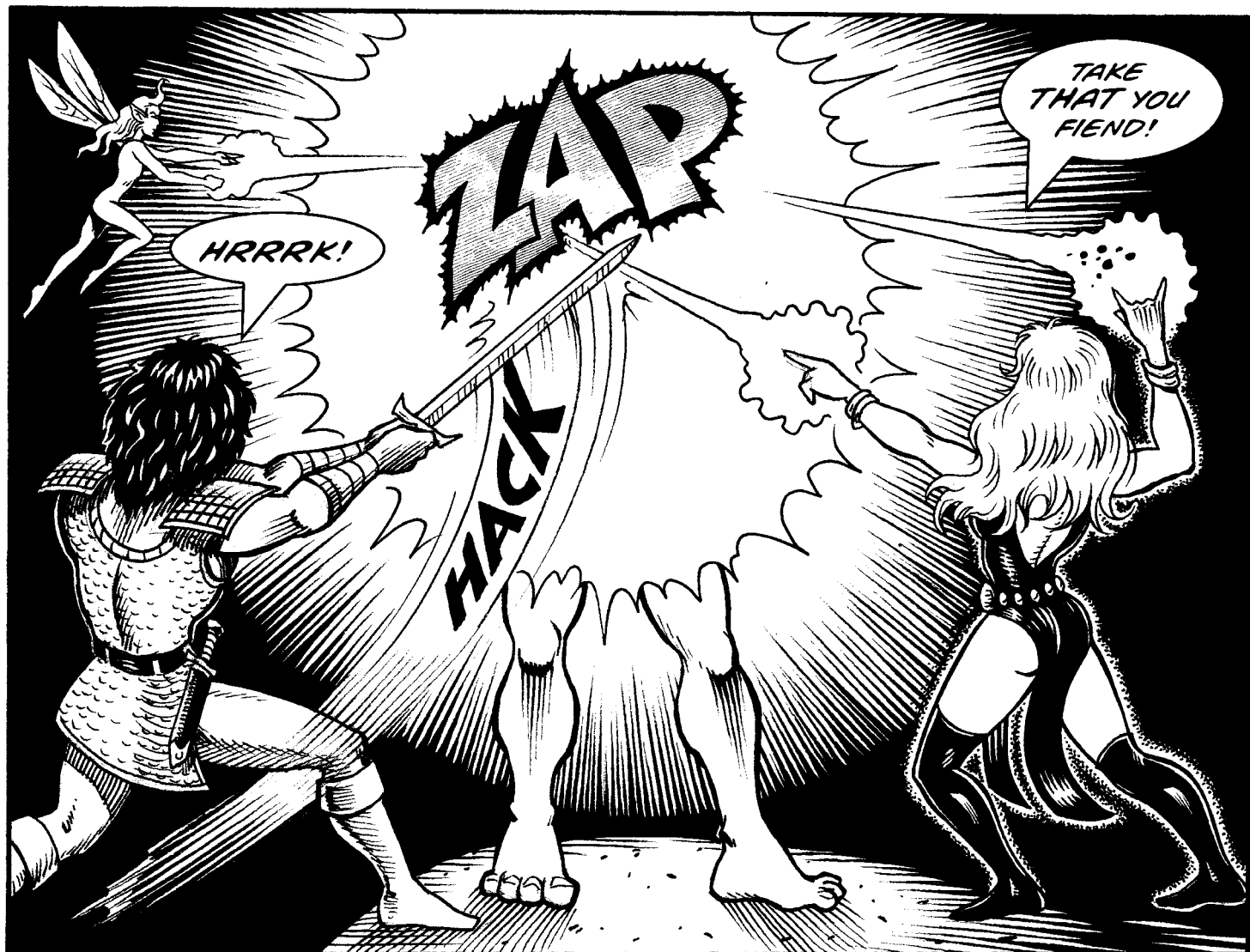

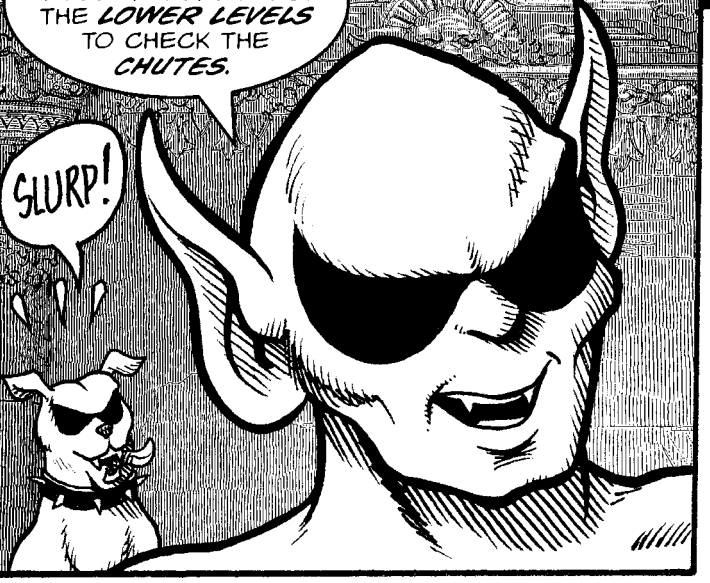
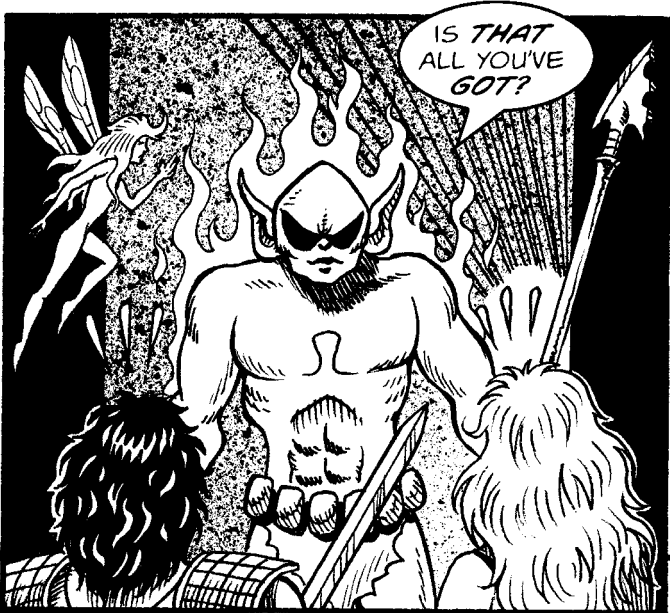

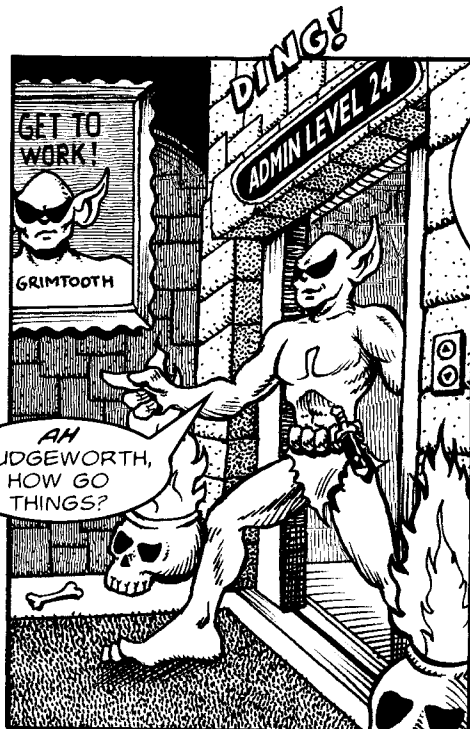
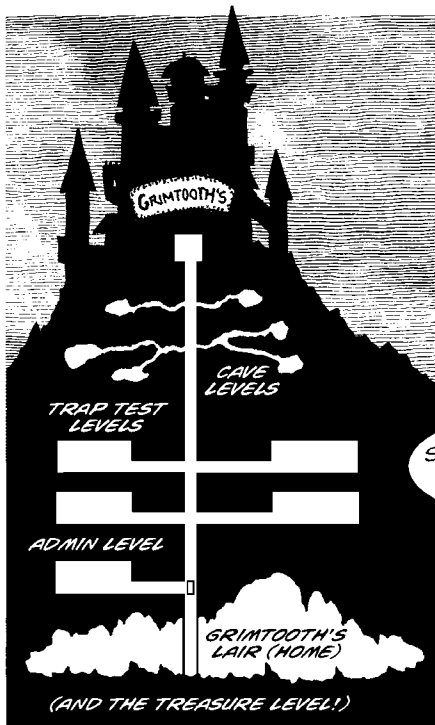

AH SLUGG WORTH, HOW GO THINGS?

MASTER GRIMTOOTH, WELCOME BACK! ALL GOES WELL. THAT NEW SHIPMENT OF CHAIN-SAWS CAME IN, SO WE HAVE BEGUN BUILDING THE BOUNCING CHAINSAW TRAP. DID YOU FIND WHAT YOU NEEDED FOR THE 101ST TRAP?

YES... INDEED I DID.



EVERYTHING IS IN PLACE, AND WHAT I FOUND WAS PERFECT FOR THE TASK. ANYTHING ELSE TO REPORT SLUGG WORTH?

WELL, UH THERE IS ANOTHER MATTER SIR...



IT'S YOUR SISTER...

SHE'S HERE



WHAT?!



DAMMIT SLUGG WORTH! YOU KNOW SHE'S NOTHING BUT TROUBLE! HOW DID SHE GET HERE? WHERE IS SHE NOW?!

S-SHE ARRIVED YESTERDAY VIA DRAGON! I-I THINK SHE'S IN YOUR OFFICE

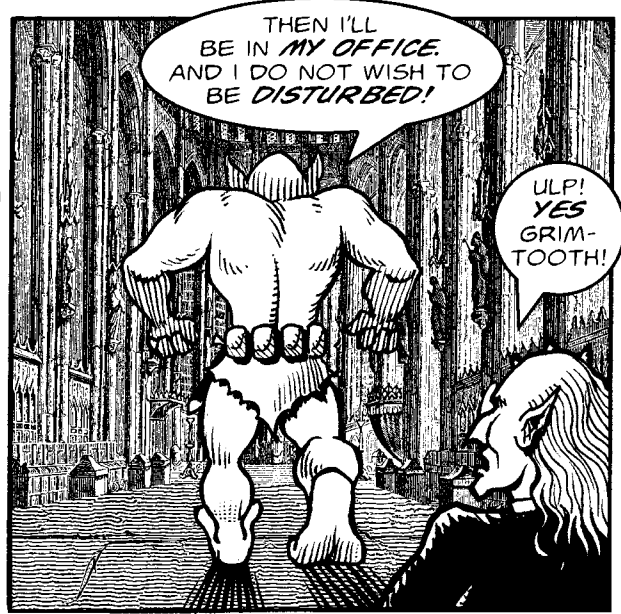

THEN I'LL BE IN MY OFFICE. AND I DO NOT WISH TO BE DISTURBED!

ULP! YES GRIM-TOOTH!



GRIMTINA!!!

WHAT ARE YOU DOING HERE!?! YOU'RE SUPPOSED TO BE AT ST. ANDRE'S SCHOOL FOR WAYWARD TROLLETTES!

GLEEP!

BIG BROTHER! I-I HAD TO COME HOME...



YEAH, SEE, LIKE THE SCHOOL BURNED DOWN. I THINK IT WAS DRAGONS...



DRAGONS WAS IT?... DIDN'T YOU ARRIVE HERE BY DRAGON?

UHH YEAH..

A PET DRAGON PERHAPS?

oh fudge!



OK, OK - YOU GOT ME! MY DRAGON BURNED DOWN THE SCHOOL AND THEY BANISHED ME, SO I CAME HOME. DID YOU MISS ME?

NOT FOR A SECOND. THAT WAS THE LAST TROLL SCHOOL IN THE REALM! NOW WHAT'LL WE DO WITH YOU?



I CAN ALWAYS HELP YOU WITH YOUR NEXT TRAPS BOOKS!

WHAT!? RIDICULOUS.

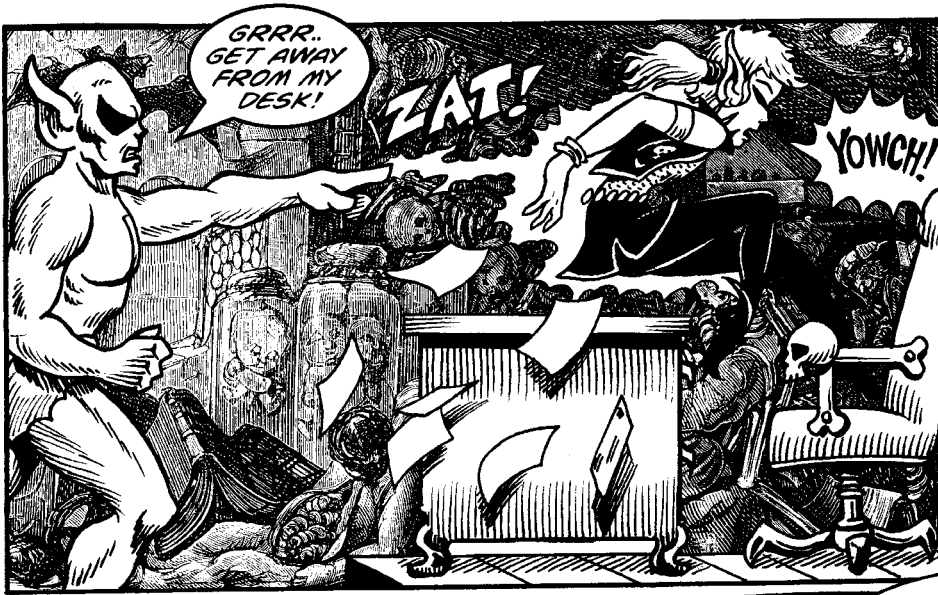

???

55 Crompton

???

GRIMTOOTH'S PUZZLE BOOK



Ah, my dear friend Murphy has struck again. The Traps Too book has been so popular that we have sold out of all copies, and it is time to reprint. Between the time we originally printed it and now, we have changed printers. The old printer used to print 8 pages at a time, and the new printer prints 16 pages at a time. Yes, you guessed it. Traps Too (and apparently most of our old books) had an odd number of 8 page groups in it! Our penny-pinching publisher [and Penny is really getting annoyed too] was going to print 8 pages of ads in the back of the book, but I "persuaded" him to let me provide you with a little more entertainment. I have long wanted to publish my own personal line of "Grimtooth's Puzzle Books" (tm), but failed to convince the accountants that anyone would buy such a book. (You would buy anything with **MY** name on it, wouldn't you?) So I'm taking this opportunity to come up with 5 or 6 pages of "fun" puzzles. Don't look in the back for any "solutions". Solution pages are for wimps. And don't let me hear anyone complaining that these are "too hard"; that the maze is too tiny and hurts your eyes; or the clues are too vague. Of **COURSE** it's hard. These are **GRIMTOOTH'S** puzzles!

I expect you all to keep working on these until you have solved them all. No excuses. However, after you have finished, if you want a copy of the official solutions (just to check your work of course) you may send a **STAMPED** self addressed envelope to: Grimtooth's Puzzle Solutions, PO Box 8467, Scottsdale, AZ 85252. This will of course give our greedy publisher a chance to sell your name and address to plentiful peddlers of produce, but that's ok, since I get a commission. [a little reminder: a stamped self addressed envelope, also known as an **SASE**, is an envelope addressed to **YOU** with a **POSTAGE STAMP** on it. Anyone who can't correctly figure out **THAT** little puzzle will **NOT** get a solution. Instead, his or her letter will be passed around as an example of the pitiful state of education in our country today. Our foreign friends are welcome to send a postal reply coupon instead of the stamp.] And as long as you are writing, we welcome your comments about the puzzles. But remember, **I** will be reading them!

Enough of that: on to the puzzles!

Grim



MAZE MADNESS!



OK brave [foolish] adventurers. Your first task is to complete a maze. Adventurers love mazes, especially if there is gold at the end. The rules are simple enough. Start at the left side of the page, at any entrance you care to. Try to find the one true path all the way to the treasure room at the lower right. Don't touch the walls (they are electrified!). You will note that there is a pit in the lower left hand corner, with lots of corridors leading to it. If you should find yourself passing through the room with the pit (heh, heh) you must roll a six-sided die [preferably Flying Buffalo DEATH DICE (tm)]. If a one comes up on the die roll, you fall into the pit, and you lose! Roll the die each time you pass through the pit room.

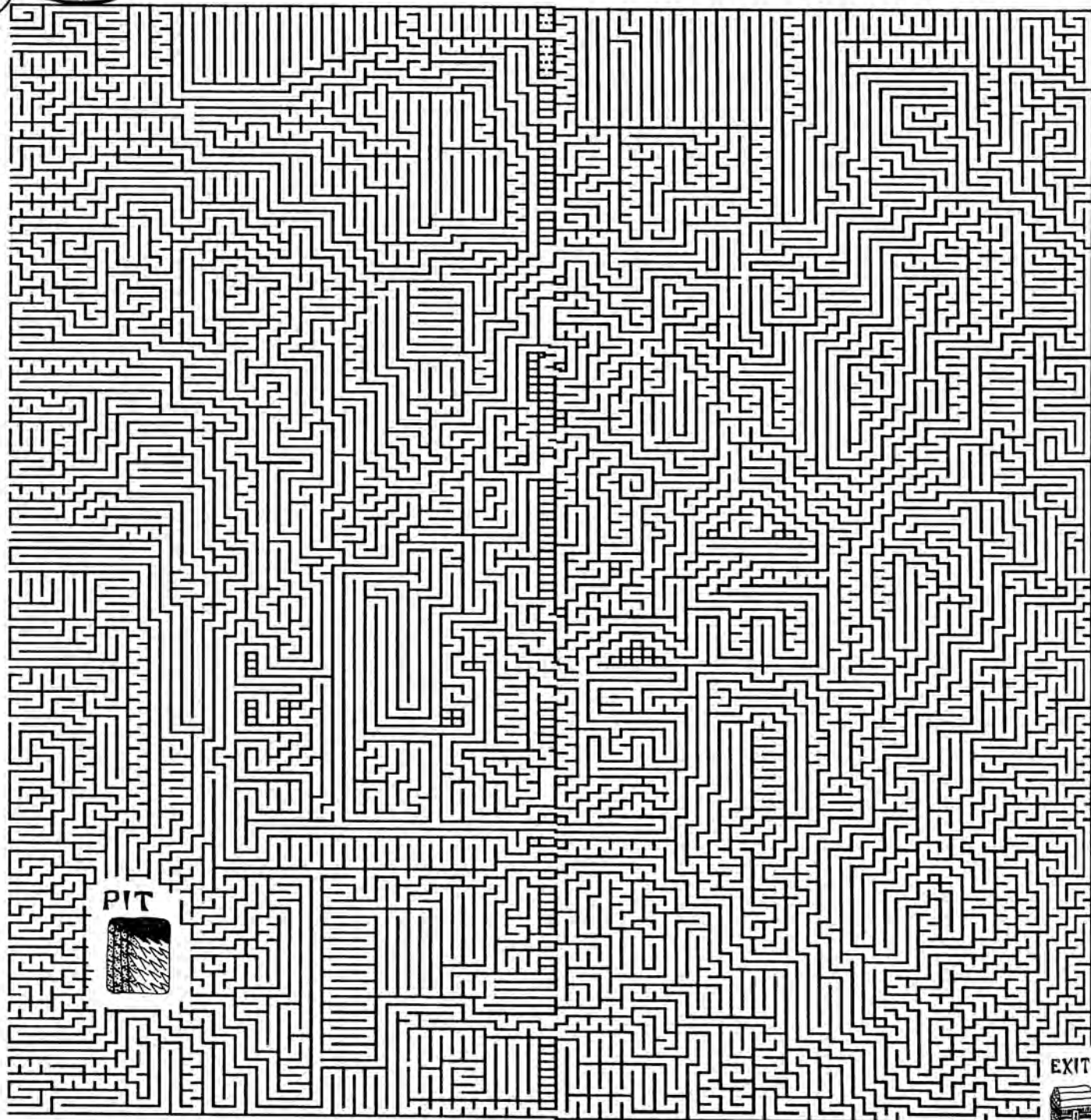

PIT



EXIT





"SEARCH FOR TRAPS."

TRAAYRE VAELCGNIRPS
 RKISSSS MOKEYTORCHU
 AP IPDDD LOGFOREWOHS
 GOOSETRALRTBARCOPP
 LODES OF FUNNOTKOIAE
 UPPER OF OOE S IT IDNP N
 EYATIMFUNRORAE O OYS
 GFIRE AND ICEDRROOTI
 EIAUTNODEADENDDAOO
 MVI NOYOETA EAOEY ION
 SEI ARTXMIYTS ANOTCL
 ORTLNEE OOBTHECUPOA
 BALS GNI RPS OREAROAD
 STIETTOVEETHBAATLD
 TTIEVAHSEYEEHTNONE
 OLVT OCL YMMUMDEGGIR
 RIEDDLOGSUINEGGIRT
 LVRRRAESTALAIRUBLVY
 E INCASE OFFIRENTDOE

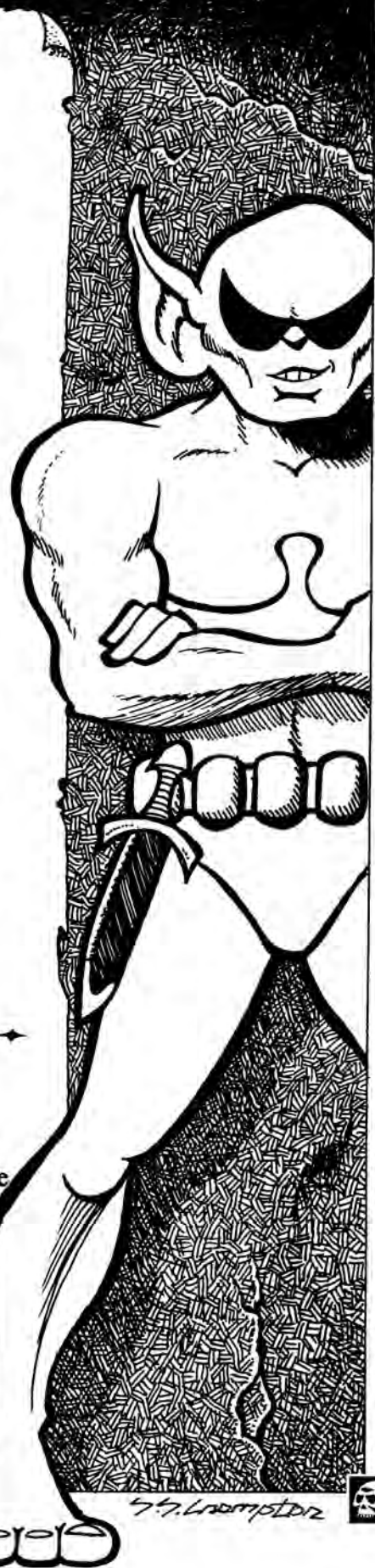

Now here's an easy one: hidden in the matrix above are the names of twenty one traps from this book. They may be written forward, backward, up, down, or diagonally. Try to find them all. If you "miss" one perhaps it won't "miss" you!



CRYPTOGRAM

R.I.P.

Now one of my personal favorites: the cryptogram. These are simple transposition codes that are often used to hide clues to the treasure. Any adventurer worth his salt should be able to figure these out with little effort. (To add a little spice, you might try lighting a fuse of some sort as you start, and try to get them all solved before the "Big Bang".) Each of these puzzles is a short quote or message. For each letter in the message I have substituted a different letter of the alphabet. For instance, instead of "E" I might use "R" so that "THE" might come out "ZMR". In any one message I have used the same letter throughout (once you figure that "R" means "E", you can replace all the "R's" in the message with "E's"), but each of the messages uses a different code. You can use the number of times a letter appears in the message as a clue (for example, "E" is the letter used most in the English alphabet), or the length of words (three letter words, for instance, are often "the"). Have fun with number five!

1. SQYD QH DMOYO DXJRY MJCLFU WOOF VOYLUFOV
WK SOXO SQXDJPY JXOFD VOJVPK OFQZUM.

2. ESSOVEMUGE GNA DSUX RX VUES KIMTDEFUKX.

3. THIS AS RICH FOLK SUE TOM TIHK GNUR IHH
UPON LBO DUNHY.

4. TALK AS KONLN LNIKNIBNL FUN BATTNUBVFVW
RUARFEFIGF.

5. SEX CAN OXN FCT TUG ECS HIS SEX BUS FUS
TUG VCS.

REBUS PUZZLE

Below are arranged the names of some of the more notorious contributors to my first two volumes. Their names are as plain as day for a troll to read. However, you humans may have trouble, so I shall explain the rules of a Rebus. You must decipher the picture, then add or subtract letters based on the + or - symbols. A space between pictures with no + or - means the beginning of a new word. Some pictures have a small arrow which points to a specific item in a drawing. Being trollish, I of course put the most difficult one first and the easiest at the end.

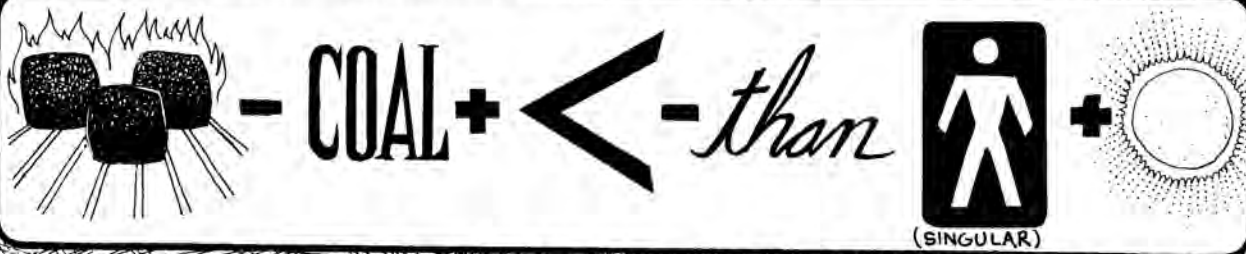
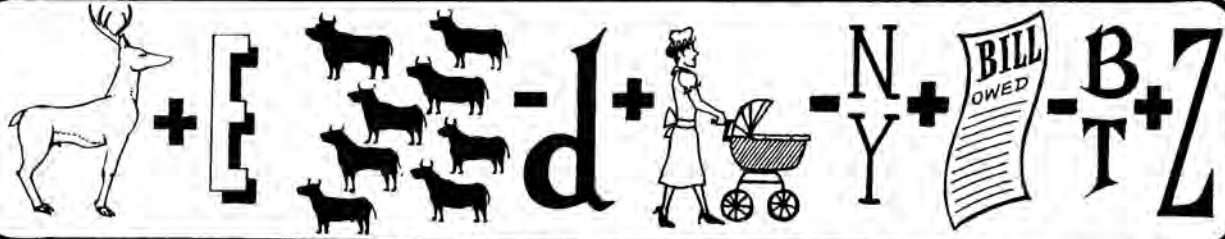

THE THINKER



1	E	2	E	3	D		4	L	5	D	6	B		7	F	8	B	9	H			
		10	N	11	M	12	M	13	G	14	M	15	Q	16	A	17	E	18	J	19	G	
		20	C	21	K	22	I			23	L	24	P	25	C	26	G			27	Q	
28	A	29	H	30	B			31	H	32	K	33	B	34	F	35	J	36	P	37	L	
38	H	39	Q	40	A			41	D	42	N	43	K	44	L	45	N	46	G	47	N	
48	A			49	F			50	D	51	L			52	K	53	Q			54	M	
55	I	56	J	57	M	58	N	59	F	60	B	61	N	62	M			63	M	64	K	
65	J	66	P	67	J	68	Q	69	G	70	J											

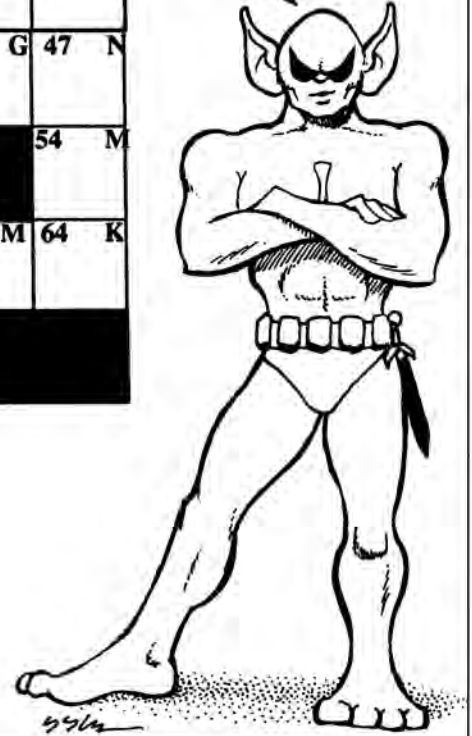

- A. _____ Osculate.
48 28 16 40
- B. _____ Without exception.
6 33 60 8 30
- C. _____ Northwest (abbr.)
25 20
- D. _____ What every adventurer hopes to get (quickly).
3 30 41 5
- E. _____ Many times
2 1 17
- F. _____ Something you may lose if you dare to enter Grimtooth's Lair.
59 49 7 34
- G. _____ A reckoning.
26 69 46 19 13
- H. _____ Something you'll find in Grimtooth's Lair.
29 38 31 9
- I. _____ Some would say Grimtooth is stronger than one of these.
22 35
- J. _____ A river in Texas.
35 67 18 56 70 65
- K. _____ Grimtooth's favorite kind of trap.
32 64 52 43 21
- L. _____ The condition of the spikes in the "Wet Pit".
23 37 51 4 44
- M. _____ An instrument for measuring the amperes in your electrical trap.
11 12 14 54 62 37 63
- N. _____ Kobold.
10 47 45 58 42 61
- P. _____ What most adventurers want most after they enter Grimtooth's Lair.
66 24 36
- Q. _____ Mother of pearl.
33 15 27 68 39

This is a special kind of crossword puzzle. The puzzle is a quote from a well-known magazine. When you get done, the first letters of the clues will spell out the name of the person who said it, and the magazine in which it appeared. You can use the puzzle to help you figure out the clues, or the clues to help you figure out the puzzle. Note that as you fill in the clues, the letters go in the numbered spaces in the puzzle also.

Bye Now!
~ Grim





Grimtooth's Traps Too and Fudge

by Ann Dupuis, Joseph P. Gill, and Brett Sanger

Grimtooth's traps are best used as obstacles to provide roleplaying and puzzle-solving opportunities. Much of the interaction between traps and characters (as they try to detect, avoid, or disarm) can be "fudged," handled through description rather than dice rolls. GMs should adjust the Difficulty Levels and other stats to suit specific campaigns.

Fudge Game Stats

We use the following attributes and skills as a "standard" for defining *Fudge* game stats for Grimtooth's Traps. GMs should substitute equivalent traits if they don't use the specific attributes and skills listed below.

Reasoning: use when character attempts to disarm a trap. May substitute skills such as Disarm Trap, Engineer, etc.

Perception: use to determine if a character can spot a trap before activating it. May substitute skills such as Detect Traps, Observation, Search, etc. GM may roll in secret.

Willpower: use as a save against magic or when "common sense" may help the character survive. May substitute Magic Resistance Gift, etc.

Strength: use whenever a character needs physical strength to break free of restraints, force open a door, etc. May substitute Escape Artist and similar skills in some situations.

Agility: use when a character attempts to avoid an activated trap by jumping out of the way, etc. May substitute Acrobatics/Tumbling, Balance, Jumping, Running, or other skill based on circumstances.

Health: use when a character has been exposed to poison or extreme physical stress.

Substituting Skills

When substituting a skill check rather than rolling against an attribute, reduce the Difficulty Level by one. For example, if a character tries to climb a wall to escape a trap, the Difficulty Level might be Good for Agility but only Fair if the character uses a Climbing skill. This reflects the advantages of training and experience over raw talent.

Damage Factors

We've assigned Damage Factors to the traps that do physical damage to characters unlucky (or careless) enough to get caught in them. Use these as a guide to determine whether a character is Hurt or worse. Note that many traps have Damage Factors of 9 or higher, indicating that the trap is lethal. The GM decides when "Near Death" becomes "Dead" (instantaneously, in some cases).

<i>Damage</i> :	1-2	3-4	5-6	7-8	9+
<i>Wounds</i> :	Scratch	Hurt	Very Hurt	Incap.	Nr. Death

If you wish to add an element of randomness to the amount of damage done by a sprung trap, adjust damage points by the number of levels by which the character lost the attempt to evade the trap once sprung. For example, if the Difficulty Level for evading a trap is Superb, a character with a Fair Agility result would suffer an additional 3 damage points (having missed the Difficulty Level by 3).

Alternatively, use a Situational Roll to adjust damage points (see *Falling*, next page).

About Fudge

Fudge is a roleplaying game written by Steffan O'Sullivan, with extensive input from the Usenet community of rec.games.design and other online forums. The core rules of *Fudge* are available free on the Internet at <http://www.fudgerpg.com> and other sites. *Fudge* was designed to be customized, and may be used with any gaming genre. *Fudge* gamemasters and game designers are encouraged to modify *Fudge* to suit their needs, and to share their modifications and additions with the *Fudge* community. The *Fudge* game system is copyrighted ©2000 by Grey Ghost Press, Inc., and is available for use under the Open Game License. See the [fudgerpg.com](http://www.fudgerpg.com) website for more information.

Trademark Notice

The *Fudge System* logo is a trademark of Grey Ghost Press, Inc., and is used under license. Logo design by Daniel M. Davis, www.agyris.net.

Grimtooth's Traps Too and Fudge

Falling

Use the following chart to determine base damage from a fall. Make a Situational Roll (a roll of Fudge dice or equivalent for a result of -4 to +4, no trait involved) and subtract the result from the damage done. Remember, subtracting a negative number is the same as adding a positive number. If the Situational Roll is Terrible (-3) damage will be increased by 3 points. Then compare the amount of damage to the Wound Track (see *Damage Factors*, above) to determine whether the character is Hurt, Near Death, or whatever.

Distance of Fall (round up)	Damage Points
10'	3
20'	4
30'	5
40'	6
60'	7
80'	8
100'	9
120'	10

Falling characters may attempt to land on their feet and roll with the impact. A Fair or better Acrobatics result or Good Agility allows the character to reduce damage by one Wound Level. For example, a character falling 20' with a Fair Situational Roll (-0 to damage) would normally suffer 4 points (a "Hurt" result). With a successful Acrobatics or Agility roll, the character would only suffer a "Scratch."

Poisons

Poisons may be rated for their potency, on the Terrible - Superb scale. Effects vary, as do methods of exposure. Contact poisons must touch bare skin to have any effect. Other poisons must be imbibed, or inhaled. Possible effects include unconsciousness, physical damage (equivalent to wounds), paralysis, etc.

When a character is exposed to a poison, make a Health roll and compare against the poison's potency. If the result equals or exceeds the poison's potency, the character fights off the worst effects of the poison and takes reduced damage, suffers lesser effects, or recovers more quickly. The actual effects are up to the GM.

What's Fudge?

Fudge is a customizable roleplaying game that each Game Master adjusts to suit a specific genre, campaign world, and gaming style. Although every *Fudge* game will be different, there are some game design decisions at the core of *Fudge* that are used by most Game Masters.

Characters and Character Traits

Fudge characters are described by "traits," including attributes, skills, gifts, and faults. *Fudge* uses ordinary words to describe attributes and skills:

Superb
Great
Good
Fair
Mediocre
Poor
Terrible

There is an additional level: Legendary, which is beyond Superb, GMs may restrict Legendary traits to non-player characters.

Most attributes default to Fair (average). Most skills default to Poor - it takes training and experience to improve a given skill.

Character creation is also customizable. Players who are comfortable with "just fudging it" may simply describe their characters in *Fudge* terms (subject to GM approval). *Fudge* also offers several more "objective" methods of character creation.

Action Resolution

For any action the player character wishes to perform, the GM must determine which trait is tested. Some actions are so easy that the character succeeds automatically; others are impossible (no rolls needed).

When the outcome of a given action is uncertain, players roll dice and add the results (from -4 to +4) to their character's trait level. "Fair" plus 2, for example, is "Great." This is compared either to a GM-set Difficulty Level (if the action is unopposed by any character or NPC) or against an opponent's trait level plus dice modifier.

Difficulty Level

The GM will set a Difficulty Level when a character tries an Unopposed Action. If the character's trait plus the dice roll modifier meets or exceeds the Difficulty Level, the action succeeds.

For example, a character with a Fair Detect Trap skill would need a +1 result to detect a trap if the GM has set the Difficulty Level to Good. (Good is one level higher than Fair on the *Fudge* trait scale.) A -1 modifier would produce a Mediocre attempt at detecting the trap; unfortunately for the character, not good enough!

Opposed Actions

When a character's actions are Opposed by an opponent, the character's trait plus dice modifier is compared to the opponent's trait plus dice modifier.

Relative Degree

This refers to how well a character did compared to another participant in an Opposed Action. The relative

continued next page...

Grimtooth's Traps Too and Fudge

If the poison is one that causes damage, it should be assigned a Damage Factor. Use the Relative Degree by which the character wins (or loses!) the Health Roll to adjust the damage done. For example, a contact poison with Good Potency and Damage Factor 4 would cause "just a Scratch" with a Superb Health Roll (Damage Factor 4 minus Relative Degree of 2), and would Incapacitate a character who got a Terrible result on the Health Roll (Damage Factor 4 minus Relative Degree of -4 for a total of 8 damage points).

Chapter 1: Room Traps

Beware of Low Ceiling

Fair Perception spots the trap. Superb Agility to jump out of the way. Damage Factor is 10.

The Teeter-Totter Room

Fair Perception spots the trap. Good Agility to jump off. Damage depends on what the characters fall into.

One Way or Another

Great Perception to spot the trap. Superb Agility to avoid. Damage Factor 15 to characters who get squashed. Damage Factor 5 for characters bashed into the room. Damage from pits and chest traps left to GM.

Toe-Tickler

Good Perception to spot the trap. Good Agility to avoid the spears. Damage Factor 4 for spears. Poor or worse Agility roll results in one or more broken shins.

Fire and Ice

Great Perception to spot the trap. Superb Agility to avoid the spikes. Damage Factor 6 for spikes. Opening either trap door will likely be fatal. GMs might allow a Reasoning roll to avoid these trap doors.

Door-Lover's Room

Superb Agility to negotiate the ledge. Spiders should be fairly easy to kill if the delvers decide to do that. Great Perception to detect chute trap. Superb Agility avoids

...continued from previous page

degree is expressed as a number of levels. If a PC gets a result of Mediocre in combat against an opponent with a Good result, the relative degree is -2 from the character's perspective, and +2 from the opponent's perspective. This Relative Degree affects how much damage a character suffers in combat.

Fudge Dice and Other Random Generators

Fudge dice are six-sided dice with two sides marked + (+1), two sides marked - (-1), and two sides left blank (+/-0). Rolling four Fudge dice (4dF) gives results from -4 (sub-Terrible) to +4 (trans-Superb).

Alternative 3d6 dice method: Roll 3 six-sided dice. Add the numbers and compare to the following table:

Rolled								
3-4	5	6-7	8-9	10-11	12-13	14-15	16	17-18
-4	-3	-2	-1	+0	+1	+2	+3	+4
Result								

Wounds

Damage to a character can be described as being at one of seven stages of severity:

- Undamaged (no wounds at all)
- Just a Scratch (no real game effect)
- Hurt (-1 to actions)
- Very Hurt (-2 to actions)
- Incapacitated (only the most basic actions allowed)
- Near Death (unconscious; death without medical help)
- Dead

Determining Wound Levels

Fudge offers many ways to track combat damage. The Objective Damage System assumes each character will have an Offensive Damage Factor (the total of modifiers, including any applicable Strength and Scale bonuses, that reflects the deadliness of the weapon used) and a Defensive Damage Factor (the total of modifiers, including Scale and armor, that reflects the character's ability to withstand or avoid damage). To determine how much damage is done in a given combat round, use the following formula:

$$\text{Winner's Relative Degree} + \text{Offensive Damage Factor} - \text{Loser's Defensive Damage Factor}$$

<i>Damage:</i>	1-2	3-4	5-6	7-8	9+
	<input type="checkbox"/> <input type="checkbox"/> <input type="checkbox"/>	<input type="checkbox"/>	<input type="checkbox"/>	<input type="checkbox"/>	<input type="checkbox"/>
<i>Wounds:</i>	Scratch	Hurt	Very Hurt	Incap.	Nr. Death

Most characters can withstand three Scratches, one Hurt, and one Very Hurt. Further Scratches are marked as Hurts, further Hurts are marked as Very Hurt, etc.

For more cinematic games, GMs may adjust the wound boxes, allowing two Hurts instead of one, for example:

<i>Damage:</i>	1-2	3-4	5-6	7-8	9+
	<input type="checkbox"/> <input type="checkbox"/> <input type="checkbox"/>	<input type="checkbox"/> <input type="checkbox"/>	<input type="checkbox"/>	<input type="checkbox"/>	<input type="checkbox"/>
<i>Wounds:</i>	Scratch	Hurt	Very Hurt	Incap.	Nr. Death

Free Fudge!

You can download a free copy of the **Fudge** roleplaying game at <http://www.fudgerpg.com>.

Grimtooth's Traps Too and Fudge

dropping into the chute. Superb Agility allows deliver to catch himself in the chute. Good Climbing allows deliver to climb back up the chute. Factor is as per falling 30 feet, plus any damage caused by giant poisonous spiders (Poison Potency = Fair, Effect = Paralyzation)

See-Saw Room

No Perception roll needed to spot the secret doors. Superb Perception required to notice trap nature of room. Superb Agility to avoid getting squished by the statues once the trap is sprung. Damage depends on what the GM puts into the glass globes.

You Rang?

Fair Engineering or similar skill to notice nature of room. Damage Factor 5 for swinging ball. Characters falling from the ball take 15' falling damage. Characters will be Deafened (Stunned) for one minute (-1 to all actions).

Dinner Gong

Good Perception spots the trap. Good Reasoning disables the generator. Superb Strength to free oneself. Game Master determines monster.

The Hall of the Memorial Carpet

Great Perception reveals nature of trap. Good Reasoning disables the mechanism. The trap is fatal if activated. Players should be able to figure out that alcoves are safe zones; allow characters to notice this with a Mediocre Reasoning if the players miss it.

The Safe-Cracker's Nemesis

Good Perception identifies nature of the floor. Great Reasoning disables the mechanism. Superb Lockpicking to open the safe if the GM decides there's a secret door behind it. If there is no secret passageway, no attempt to open the safe will be successful; each attempt will cause the floor to retract. GM determines depth of pit and difficulty level for jumping across. Great Agility to climb around the pit using the joint between wall and sliding floor.

Troll's Bridge-Work

Great Perception to find pressure plate or notice nature of trap. Fair Reasoning to disable the pressure plate. Characters must be clever to escape; Superb difficulty level.

Cretin in the Circular Citadel

Great Reasoning to divine the reason for the slack expressions. Superb Willpower roll to resist the geas (characters with any form of magic resistance will get a bonus).

Death of 1000 Slices

Good Perception to notice that the walls will fold in when trap is triggered. Superb Agility to avoid getting sliced when sprung. Good Agility to negotiate the daggers

(Great if greased). Great Reasoning disables mechanism. Damage Factor 9 for falling walls. Damage Factor 2 for dagger if character falls.

Roulette Room

Great Perception to spot and nullify effectiveness of trap. Superb Agility to avoid getting tossed out. Legendary Reasoning to disable the mechanism. Superb Reasoning to avoid confusion. Superb Agility to avoid falling. If the GM includes the bouncing ball, a character will be hit by the ball on a Situational Roll of Poor or worse. Damage Factor 4.

The Ceiling Trap

Superb Perception to spot trap. Legendary Reasoning to disable. Damage Factor 20.

Burial at Sea

This trap should be roleplayed. Characters who can't swim probably won't drown as it's all over in 4 minutes – but you can make them think they will! Feel free to include additional traps or monsters beyond the outflow hole.

Fruits of Misfortune

Superb Perception to notice gas after fruit is picked. Gas functions as poison (Potency = Fair +1 for each fruit picked, Effect = Unconsciousness). GM may add monsters to take advantage of the incapacitated characters.

Let Me At 'Em

Superb Perception to spot trap. Legendary Reasoning to disable. Damage Factor 20.

Lodes of Fun

Fair Perception to spot secret door. Superb Perception to spot fan activator on plain door, Superb Reasoning to disable the fan activator. Legendary Reasoning to disable fan after activation. Lodestone covered armor is -2 to all actions.

The Better Mousetrap

Superb Reasoning to deactivate mousetrap itself. Superb Reasoning to deactivate pressure plate under the striker. Cats will be freed if trap is triggered. Legendary Agility to avoid being hit by the striker if on pressure plate. Damage Factor 4 for striker.

Kiss of Death

Legendary Agility to avoid the sword thrust. Damage Factor 4 – character will be Near Death (or dead) if hit in the head. This trap is magical in nature, and cannot be deactivated without dispelling the magic (and hence any possibility of a boon).

Another Brick Through the Wall

Fair Perception to spot nature of the false wall. Superb Reasoning to prevent the grate from activating if located

Grimtooth's Traps Too and Fudge

on a Superb perception to find the activation device. Damage Factor 2 for fake wall. Damage Factor 20 for grate.

Sink or Swim

Fair Perception to notice true nature of the floor. Great Reasoning to disable the floor draining mechanism. Good Perception to discover secret door. Great Agility to avoid being hit by the water. Damage Factor 4 for spikes.

Archimedes Revenge

Superb Perception to spot nature of trap. Fair Perception to find the secret door. Fair Reasoning to prevent secret door from opening if nature of trap and secret door have been discovered. Damage depends on what's behind the secret door.

Shock Treatment

Superb Perception to determine nature of trap. Superb Reasoning to disable. Poor Agility to avoid falling spear; Superb Agility to avoid electrocution. Damage Factor 3 for spear, 8 for shocking damage.

Chapter 2: Corridor Traps

Shower Of Gold

Legendary Perception to divine the nature of the trap (Great Perception will reveal the seam in the floor). Superb Reasoning to deduce a means to disable the trap. Superb Agility to avoid the shower of gold. Damage Factor 4, but characters trapped underneath the shower will continue to take damage until freed or the gold runs out.

Acid Rain

Great Perception to reveal the seam in the floor, Superb Perception to notice the basic functioning of the trap. Superb Reasoning to disable the mechanism. Superb Agility to avoid the damage, otherwise treat the acid as an external poison (Potency = Good, Damage Factor 4).

Wet Pit

Superb Perception to notice the trap, should anyone be looking for it. Great Agility to leap away before the floor falls away. Great Reasoning to disable the trap. For maximum effect, try to convince the players they are in truly desperate straits.

Whipped-Cream Pit

Superb Perception to notice the trap. Once noticed, Great Reasoning can disable the trap. Great Agility to leap away if the trap is triggered. Treat all tasks done within Whipped Cream as one level more difficult.

Moebius Hallway

Superb Perception will notice the nature of the walkway

before long, and if the characters become suspicious, Superb Reasoning will also determine its method. Falling rules apply to characters who step off. Generous GMs will reduce falling damage for characters who prepare themselves or attempt to put themselves nearest to "vertical."

Now You See It, Now You're Dead!

Superb Perception to notice the mirrors. Once suspicious, Superb Perception can discover the nature of the trap and avoid it. If sprung, Superb Agility can twist and ricochet the character so as to avoid all significant damage, otherwise the Damage Factor is 6.

Suspension Ladder

Great Perception will notice the nature of the upper rungs, hopefully before the trap is sprung. Superb Agility can grasp the ladder as a rung falls away. Superb Reasoning can disable the mechanism once it is discovered (requires Superb Perception and a search, which might be difficult if the trap has been sprung!) Damage as per a 40' fall.

Step This Way, Please

Superb Agility can dodge the jet of flame. Superb Reasoning can disable the trap, but since the "secret" of the trap isn't the pressure plate but instead what happens when the door opens, the characters may be injured regardless. Superb Agility is required to avoid the post. Damage Factor 4 for the flame, Damage Factor 5 for the post.

Fore!

Superb Agility to avoid the oncoming boulder (Damage Factor 6). Superb Perception can locate the trigger if sought, and Superb Reasoning can disable it.

Beware Flash Flood

Great Perception will notice the bell Superb Reflexes to cross without causing the bell to ring (increase difficulty if more than one character is moving across the bridge at once) Once the bell is reached, it can be disabled with a Mediocre Reasoning roll. Superb Perception (again, assuming range of vision) will notice something odd about the ceiling.

We All Fall Down

Great Perception will notice the floor seam 20' from the door. Superb Perception can find the mechanism, which can be disabled with a Good Reasoning roll.

Beer Barrel Stairwell

Superb Perception to notice the trapped step. If sprung, wrenching the trapped leg free before the barrels hit requires a Good Strength roll (one chance only) and causes a Scratch. Characters not trapped can avoid the barrels with Great Agility rolls. A trapped character can free himself without injury if there's no hurry. Damage Factor 5 for barrels.

Grimtooth's Traps Too and Fudge

Hit 'Im Where He Ain't

Superb Perception to find trap if searching. Good Reasoning to disable. If sprung, Great Agility to avoid (Good Agility if the character jumps forward.) Damage Factor is 5 either way, but impaling yourself is more embarrassing.

I'll Take A Stab At That

Damage Factor is determined by the character's own attack, handled as an Unopposed Action (the character's not expecting to be stabbed in the back!) with Difficulty Level Mediocre. Magical senses may notice the nature of the trap.

Oil's Well That Ends Well

Great Perception will notice something odd about the room's paneling. Magical senses might notice the wall over the pit or the invisible walkway. Damage Factor is 10.

Russian Roulette Stairway

Good Perception will reveal the odd construction of the stairs as extremely suspicious. Superb Perception can find the trigger stairs, and Superb Reasoning can disable once found (or common sense can avoid them.) Great Agility can avoid damage from each trap, and each damaging trap has Damage Factor 3.

Spring Slab

Great Perception will notice the suspicious stone (not to mention the dark spot on the ceiling...). Damage Factor is 10, Superb Agility can leap off in time.

Bee-Hive Trap

Superb Perception will detect the trigger. If sprung, each character that doesn't have sufficient cover (such as another character!) will suffer Damage Factor 5.

The Double Scythe

Superb Perception to detect the trigger (the grooves for the scythes may be noticed with Good Perception). Great Reasoning to disable the trigger. A Great Agility roll is required to dodge each blade. Damage Factor is 6 for one blade, 10 if struck by both.

The Pendulum

Superb Perception is required to notice the trap or detect the trigger. Superb Reasoning can disable the trigger. Damage Factor is 10. Play up the effects of the non-lethal damage, depending on where the character was struck.

Pyromaniac's Comet

Damage Factor 6 if the gas explodes. Note that a dropped torch, or one carried by a short character, will also touch off the gas.

There and Back Again

Great Perception will notice the trap (skeletons amid the spikes might serve as a clue). Great Reasoning can prevent it from triggering. Damage Factor 5 if impaled. Hints of potential treasure amongst the skeletons can invoke player greed, making the characters easy prey.

The Mangler

Great Perception will notice the spearholes. Great Perception can detect the trigger, and Good Reasoning can disable it. Superb Agility can avoid damage, otherwise it is Damage Factor 10.

Rocky Point

Good Perception will notice the trapdoor. Superb Agility to avoid falling. Damage Factor depends on depth of pit – doubled due to the boulders, plus 2 for spikes.

Only Time Will Tile

Superb Perception to discern the nature of the floor. Great Agility will save a character from falling through the plaster. Damage Factor is as per distance fallen.

Meet the Pit

Magical senses may detect the illusion if the far side is disguised with an illusion rather than mechanical means. Superb Agility to save oneself from a fall. Damage Factor as per falling, plus 2 for spikes.

In Case of Fire

The best way to escape this trap without magic is to avoid it entirely (Good Perception or Reasoning to discern nature of black rocks; Superb Perception to notice the Orc with the lantern). Superb Agility will avoid damage only if the character is near the entrance when the trap is sprung. The trap is almost certainly fatal otherwise (Damage Factor 10 for each successive damage-inflicting circumstance).

Too Many Tentacles

Superb Perception to notice the cracks in the steel wall if examining it. Tentacles have Combat Skill Fair, Damage Factor 1 plus Poison (Potency=Fair, Effect = Damage, Damage Factor 4). Great Perception to notice each pressure plate, including the one that springs the steel wall trap. Damage as per trap sprung by pressure plate (falling damage for pits, etc.). Great Agility to avoid any sprung trap, except for the steel wall, which requires Superb Agility to leap up into the tentacles above to get out of the way. If pushed through the gelatinous wall, it's a matter of swimming to the surface (Great Swimming skill needed) while avoiding or defeating the kraken.

Chute the Loop

Great Perception to notice the trap before falling into the chute. Good Agility to avoid falling into it. Legendary

Grimtooth's Traps Too and Fudge

Agility needed to climb back up the chute before succumbing to the loop portion of the trap.

Amazing Ginsu Chute

Great Perception to notice the chute, Good Agility to avoid falling into it otherwise. Legendary Agility to climb back up the chute. Damage Factor 10 if character doesn't manage to slow descent before the split and isn't wearing solid armor.

Dead End

Great Perception to notice the chute, otherwise Good Agility to avoid falling into it. Great Perception to notice guillotine blade, Legendary Reasoning (and some means to stop descent) to disable it. Damage Factor depends on length of chute (treat as Falling except decrease Wound severity by one level). Damage Factor 2 for spikes.

Emergency Exit

Superb Agility to grab the edge of the chute before launching into the air at the exit end. Legendary Agility to climb back up the very long chute.

Chuting Gallery

Great Agility to land gracefully and ready to fight or dodge. Combat difficulties and damage factors as per monsters in barracks.

Chapter Three: Door Traps

Double Trap

Superb Perception discerns the true nature of this trap, though a kind GM might lower this by one if the player specifically states that the character is checking the door. Superb Reasoning disables the trap, but any result of Fair or worse sets it off. A Great Agility check avoids the Damage Factor 9 smash/spike combo.

Sandman/Doorman

Superb Perception spots this trap. Superb Reasoning disables it, but any result of Poor or worse will break the glass doors and start the reaction. The sleeping gas has Great Potency but causes no damage; affected characters will sleep for ten minutes for each level by which they missed their Health roll.

Spring Cleaver

Good Perception to discern the nature of this trap. Superb Reasoning disables the trap, but any result of Fair or worse sets it off. A Great Agility roll avoids all damage; otherwise consider the hand Incapacitated.

Shrieker Shrinker

Superb Perception spots this trap. Superb Reasoning disables the trap. Great Agility to roll under the falling portcullises (Damage Factor 8). Once the portcullises have dropped, Superb Perception may spot the second trap; Superb Reasoning disables it. Great Agility to tumble through the open door and avoid damage. Damage Factor 12 for the stone block.

The Catastrophic Keyhole

Superb Perception spots this trap. Superb Reasoning disables the trap. Great Agility to avoid injury from the Damage Factor 10 explosion, but Superb or better is necessary to avoid blindness.

2x4 Headache

Superb Perception spots this trap. Superb Reasoning disables the trap. Great Agility to duck in time. Damage Factor 7.

What You Don't Know Will Hurt You

This trap should be nearly impossible to detect prior to entering the revolving door. Once inside, Great Perception to spot the pit, otherwise Superb Agility to keep from falling in. Damage as per "Falling," adjusted for spikes, etc.

Backstabber

Superb Perception spots this trap. Superb Reasoning to disable. Great Agility to avoid the pole. Damage Factor 10 plus poison (Potency = Good, Effect = Damage 6).

Chapter 4: Items

They Cried With Their Boots On

Magical senses may detect this trap. Superb Willpower (or Magic Resistance) will allow the character to remove his hand from the dagger, but only a single roll is allowed. Good Agility to remove the boots without difficulty.

Magnetic Armbands

Magical senses may detect this trap. Mediocre Agility avoids dislocated shoulder (treat affected arm as Hurt for penalties and healing purposes). Great Strength required to separate armbands. All skills requiring the use of the hands or arms will be at a -3 while the armbands are joined.

Slime Gauntlet

The only game mechanic necessary to enjoy this magical gauntlet is good old-fashioned roleplaying!

Glue Gems

A Superb Perception roll *might* allow the character to notice "something strange" about these "gems." A Great Alchemy roll will reveal the gems' true nature.

Grimtooth's Traps Too and Fudge

Smokey Torch

Superb Perception to notice the noxious chemicals mid-way down the torch-head. Good Alchemy can identify. Other than extinguishing the flame early, there is no way to disable this "trap." Once smoking, visually based Perception rolls are at -2 penalty. Noxious smoke acts as poison (Potency = Great, Effect = coughing, choking, gagging).

Scold's Bridle

Magical senses may detect the nature of the crown. Once donned, only the appropriate magic will allow the crown to be removed.

For Someone Special

If a character looks under the cloth, make an Opposed Agility check against the basilisk's Superb Agility. If the character loses, he's turned to stone. A Great Health roll or magic resistance may resist the basilisk's gaze.

Gallium Grapple

Like the other items in this chapter, this is mostly a role-playing hook. Great Alchemy to recognize the gallium and be aware of its properties.

Excaliber Reprise

Radiation poisoning can be handled as a daily Health roll. After exposure for a suitable time (a month is good), require a Health roll every day. Symptoms of radiation sickness appear on a Mediocre result. On a Poor or worse Health roll, the character loses a level of Health as well.

Swiss Army Sword

Great Perception to notice the nature of the hilt. A Good Combat Roll with the sword frees the blade from the rear supports. Great Agility to avoid injury. Damage Factor 3.

Funny Money Trap

This is a magical trap immune to mundane detection.

The Heavy Coins Trap

Superb Perception to notice the coating, though not its function. Fair Alchemy to determine how to remove it.

The 'Don't Sweat It' Polearm

Superb Perception to notice the coating, Fair Alchemy to determine how to remove it. Actions involving the hands (including combat) are at -1 due to inability to shift grip.

Matchless Shield

Great Perception to spot the shield's abnormalities. Great Agility to drop the shield before being injured. Damage Factor 5, all to the shield arm.

The End of Your Rope

Good Agility to release the rope prior to his hands being burned. Treat a burned palm as a Scratch, but it's very painful to hold anything in your hand. Additional damage as per "Falling" if the rope was being used to climb.

Chapter 5: Things

Epoxy Trap

Mostly a role playing situation. Superb Strength can rip the owners out of their footwear, but not break the epoxy.

Napalm Rocks

Great Perception to notice the true nature of the "rocks." Damage Factor 4; flammable equipment may be damaged.

Genius Gold

Mostly a role playing situation. Great Perception might notice something strange after some time.

Spiderweb Fuse Trap

A suspicious character can find the fuses with Superb Perception. Damage Factor is 10.

Miss Moffat Engine of Destruction

Superb Perception to notice trap. Damage Factor 4; flammable equipment may be damaged.

Black Widow Pinata

The spiders are easy to kill, one by one. They are poisonous (Potency = Good, Effects = intense pain and cramping; paralysis and even death in more severe cases.)

Hellevator

Treat Chlorine as poison (Potency = Good, Effects = Damage 4 per 10 minutes; eye, nose, and throat irritation).

The Trojan Dragon

This is a role playing situation. Superb Perception from a charging character, or Good Perception from a character that hangs back, to notice something odd about the dragon. Good Strength to free blades trapped in the dragon mock-up. The rest of the encounter depends on what type of monster is using the dragon to ambush the characters.

Crossed Swords

Superb Perception by a suspicious character will reveal the trap, and Superb Reasoning can deactivate the trap. Damage Factor is 10 to anyone within 5' of the fireplace.

Water that Glimmers, Shimmers, and Kills

Superb Perception to notice something wrong about the water, or Great Perception if light stronger than torchlight is used. Damage Factor 10.

Grimtooth's Traps Too and Fudge

Paranoid Frustrator

This is a role playing hook. Note that increase is in appearance only, not the effectiveness of the item that is altered.

The Eyes Have It

This is a role playing hook.

Fireman's Pole

Treat this as a pit trap, with damage as per "Falling." Great Agility to stop descent before hitting the end of the too-short pole. Superb Agility to climb up the pole.

Tumble Toidee

Treat this as a pit trap, with damage as per "Falling." Legendary Agility to keep from falling into the pit if trap is activated while sitting.

Fibber McGee's Closet of Caltrops

Great Reflexes will avoid all damage. Damage Factor 4.

The First Sign of Danger

Great Agility to avoid being smashed in the face. Damage Factor 4.

Leaping Wizards

Ideally this is a role playing adventure to save the unfortunate character as she sails upwards. Should all attempts be unsuccessful, treat impact with the ceiling as though the character had "Fallen" the distance from the board to the ceiling.

The Accordion Throne

Superb Agility to leap out of the throne in time. Superb Strength check to free a character trapped by the throne. Damage Factor is 8.

The Blotomoto Trap

This is an opportunity for role playing. Contact poison (Potency = Great, Effect = extremely painful swelling). If it becomes relevant, the character is at a -2 to all tasks that require use of the affected limb.

Rigged Mummy

Exploding mummy does Damage Factor 10, reduced for characters farther than 10' away or with cover. Great Agility reduces Wound level by one (Very Hurt becomes Hurt, etc.).

The 101st Trap

Just fudge it!

Sample Monsters

When creating "monsters" for *Fudge*, simply describe them in *Fudge* terms, using only those traits that are likely to come into use during an encounter. Leave everything else to description and role-playing.

Kraken

Kraken are enormous, intelligent, malevolent squid-like creatures. They live in the depths of the ocean, but may come to the surface to hunt and wreak havoc. They've been known to drag entire galleons beneath the waves.

Combat: Good

Attacks: 8 tentacles, beak

Special: Jet propulsion, ink cloud

Scale: 25 (In *Fudge*, Scale measures mass/strength/size; it acts as a modifier to Offensive and Defensive Damage Factors. Humans are Scale 0 in most *Fudge* games. While the Kraken's size makes it hard to kill, it cannot exert its entire mass in combat — hence the disparity between its Offensive and Defensive Damage Factors.)

Offensive Damage Factors (includes Scale):

Tentacles 10

Beak 10

Defensive Damage Factors (includes Scale):

Body and Head: 25

Tentacles: 10

Combat Notes: Once a Tentacle hits a character, it can grab and hold, continuing to do 4 points of squeezing damage each combat round. Wounds inflicted on a tentacle affect that tentacle only, not the beast as a whole. Wounds inflicted on the body and head *do* affect the beast as a whole. The Kraken can eject a cloud of black ink, causing Terrible Visibility in the area.

Orc

Orcs are humanoids that subsist mostly by raiding and pillaging other communities (human or otherwise). They are hairy, brutish, and tusked.

Combat: Fair

Attacks: By weapon (battleaxe, shortsword most common)

Special: Some orcs may use primitive magic

Offensive Damage Factors: By weapon

Club: +1

Shortsword: +2

BattleAxe: +4

Add Strength bonus if individual is particularly strong

Defensive Damage Factor: By armor, plus Toughness +1

Unarmored: +1

Leather Armor: +2

Heavy Leather Armor: +3

Combat Notes: An orc's combat style depends on brute force rather than finesse or skill.

Credits

Executive Producer
Rick Loomis

Producer
Grimtooth

First Assistant to the Producer
Paul Ryan O'Connor

Second Assistant to the Producer
Patricia Ann Mueller

Third Assistant to the Producer
Michael Austin Stackpole

Director
Liz Danforth

Special Effects by
Steven S. Crompton

Design and Layout by
Canotas & Crompton, Unltd.

Opening Sequence
Jeff Dee

Storyboards
Lynn Alison Trombetta

Pre-Production Editing
Jason Sato

"Post" Production
Debbie Cady and Felicia Radzio

Accuracy and Continuity
Jim Cooper, Liz Danforth, David 'Preppie' Hart,
Tim McCausland, Carl Eichelberger

Sound Effects by
Edward C. Cooper IV

Typos by
Jason Canotas and Thessaloniki Sato

Nightwatch Security
Joe Formichella, Allen Nordendale, Terry Riseden,
Lee Russell, Jason Sato, Jimmy Walker

UK Casting
Chris Harvey

Wandering Monsters
E.L. Frederick and Ken St. Andre

Silent Film Sequences
Ugly John Carver, Pat Mueller, Paul O'Connor, Greg Shirey

Cameo Appearances by

Wally Blunder, Debbie Cady, Thessaloniki Alexandra Canotas, Edward C. Cooper IV, Steven S. Crompton, Larry DiTillio, Chuck Gaydos, Lorna Johnson, Leslie the Lizard, Steve MacGregor, Pat Mueller, Paul Ryan O'Connor, Scot Rhoads, Lee Russell, Jason Sato, Michael Stackpole, Jimmy Walker, Grimtooth, and Who else?

Special Thanks to: Alfa-Gevaert, Letraset, Formatt, CompuGraphic, Higgins, Koh-i-noor, Foto Reproductions, Alphagraphics, SethCole, The Joynt, Teepee Tempe, Smith-Corona, IBM, and Buffalo Artist Colors, who all made their contribution towards the completion of this book.

A Catalyst Product

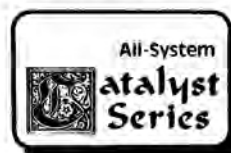

— a catalyst to spark your imagination —

Produced by



a division of Flying Buffalo Inc.

—List of Contributors—

- Chris Andrews (p. 18)
- Michael Arner (p. 5)
- Michael Austin (pp. 38, 54)
- Cliff Baird (p. 3)
- Mark Bassett (pp. 20, 21, 38, 52, 52,)
- Andy Beauchamp (pp. 10, 39)
- Jonathan Bernick (pp. 15, 52)
- James Brazier (p. 45)
- Brandon Corey (pp. 13, 14, 27, 42)
- Steve Crompton (pp. 46, 55)
- Liz Danforth (pp. 17, 21, 46, 48)
- Greg Day (pp. 4, 41)
- Cathy DeMott (p. 28)
- Larry DiTillio (pp. 6, 30, 31, 45, 48, 54, 60)
- Bob Greenwade (p. 58)
- Brian Hammond (p. 20)
- Bucky Hernandez (pp. 49, 53)
- Pat Hollister (p. 10)
- Steve Jackson (p. 57)
- Stefan Jones (pp. 55, 58)
- Rick Loomis (p. 58)
- Caroline J. Maher (pp. 5, 46)
- Dan Manning (p. 21)
- Charles Manson (p. 42)
- Brian Marrs (p. 31)
- Stephan McAllister (pp. 12, 57)
- Fred Meyer (pp. 28, 29)
- Charles Mollenhauer (p. 9)
- David Steven Moskowitz (pp. 32, 56)
- Pat Mueller (pp. 9, 44, 45, 59)
- Matt Nadelhaft (pp. 11, 25, 26)
- Paul O'Connor (p. 54)
- Adrian Passmore (p. 13)
- Ted Rassieur (p. 11)
- Scot Rhoads (pp. 8, 47)
- Lee Russel (p. 15)
- Jason Sato (pp. 2, 7)
- Matt Scholl (p. 60)
- Ken St. Andre (pp. 33, 34, 35, 36, 59)
- Michael Stackpole (pp. 13, 17, 22, 23, 24, 46)
- John Strain (p. 48)
- Barry Sullivan (pp. 24, 25)
- J.E. Todd (pp. 20, 40)
- William Toivainen (p. 56)
- Michael von Glahn (p. 3)
- James Walker (p. 29)
- Chris Weitz (p. 55)
- Bruce Woodcock (p. 40)
- P.D.J. Wright (p.32)
- Peter Yearsley (pp. 7, 26)

WHAT,
CONTRIBUTORS?
I PREFER TO
CALL THEM
"VICTIMS."

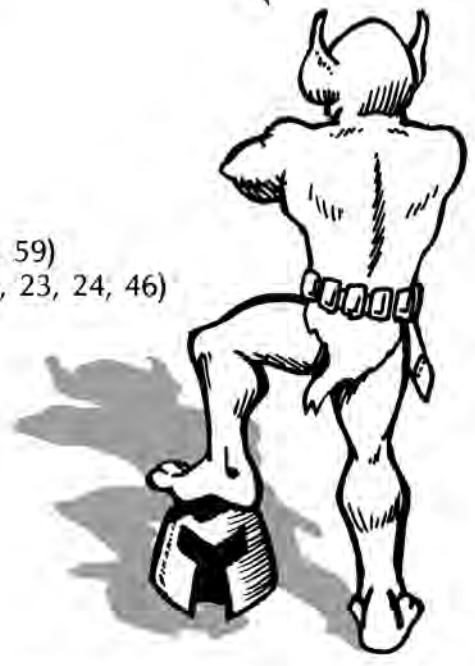

Want something you can use in ANY of your RPGs? You need a Catalyst!



All catalyst products are presented without game mechanics of any kind; the nature of things, their causes and effects, NPC (non-player character) personalities, and everything else vital to good gaming are fully described. Game Masters need only supply the appropriate game statistics to the people, places, or devices described to adapt them easily into their games. Please note that these are NOT books that are really intended for some particular game that "can be adapted" to other systems. These are genuinely for ANY fantasy or medieval role-playing game system. Try these other Catalyst books:

GRIMTOOTH'S TRAPS

There are seven Books in the Series: Grimtooth's TRAPS, TRAPS TOO, TRAPS FORE. TRAPS ATE. TRAPS LITE, TRAPS BAZAAR & DUNGEON of DOOM. Check our website or your local game store for the availability of the TRAPS books. Some of these are currently sold out BUT WILL BE REPRINTED SHORTLY. WATCH OUR WEBSITE FOR THE NEW RELEASE DATES.

CITYBOOKS

Each Citybook contains individual buildings/establishments that you can insert into your own fantasy role playing campaign. Again: there are no game-specific statistics. The idea here is to flesh-out that city you've been creating for your campaign. Use these books to fill the nooks and crannies of your own individual city.

CITYBOOK I: Butcher Baker, Candlestick Maker 120 pgs \$14.95

CITYBOOK II: Port O' Call (Sold Out)

CITYBOOK III; Deadly Nightside 96 pgs \$11.95

CITYBOOK IV: On the Road: 96 pgs \$11.95

CITYBOOK V: Sideshow 96 pgs \$11.95

CITYBOOK VI: Up Town 96 pgs \$14.95

Citybook VII: King's River 112 pgs \$14.95



LEJENTIA CAMPAIGN BOOKS

If you're tired of the same old fantasy world where everybody knows all the races, all the monsters, and all the magics, then these books are what you've been looking for! All fully described in Citybook style. Discover the world of Lejentia.

LEJENTIA CAMPAIGNS BOOK 1: Skully's Harbor 160 pgs \$14.95

LEJENTIA CAMPAIGNS BOOK 2: Fort Bevis 160 pgs \$14.95

LEJENTIA STANZA ADVENTURE PACK 56 pgs \$9.95

MAPS: PLACES OF LEGEND

Provides maps, details, and adventure ideas for such legendary places as Camelot, Atlantis, King Solomon's Mine, Capt. Nemo's submarine base, Lemuria, the 13th Floor, Bermuda Triangle, OZ, and others. Book includes maps, adventure ideas for every place & even crossover scenarios. 96 pgs \$14.95

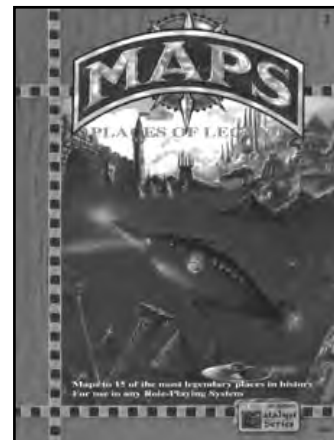

Ask for them at your local gamestore, go to www.flyingbuffalo.com or mail check to:

Flying Buffalo - PO Box 8467, Scottsdale, AZ 85252, USA

Add \$3 postage for USA orders, \$8 postage for other countries.

Award winning books for any RPG... the Classics!

Is NUCLEAR WAR unavoidable?

Is Nuclear Escalation inevitable? Is Nuclear Proliferation inescapable?

Are Weapons of Mass Destruction ever going to be found?

We don't know either, but we do know that the card game NUCLEAR WAR is the most fun you'll ever find in a box that size. Originally invented in 1965, this game makes fun of the very idea of trying to "win" a Nuclear War. You have to play it to believe it. This game's a blast! It was chosen for Games Magazine's "Games 100" for 1984. "The quintessential beer-and-pretzels' game: simple, fast, easy to learn, and loads of fun. Minimal prep time: shuffle the decks and deal." - Tim Kask, Adventure Gaming Magazine. (Boxed, 140 cards and spinner).

Nuclear War has THREE expansion sets: Nuclear Escalation, Nuclear Proliferation, and Weapons of Mass Destruction. (Add \$3 postage if you are in the USA, \$11 if you are in Canada, \$19 if you are in Europe, \$27 if you are in Australia or Asia).

All these games should be available at your favorite local game store. If not, you can find them on our webpage at www.flyingbuffalo.com or you can mail us a check or money order (add \$3 postage if you are in the USA, \$8 postage for overseas surface mail, \$20 postage for overseas airmail.) We accept Visa, Mastercard, Discover, American Express, and Paypal. American Express, and Paypal.

Suggested US retail prices:

- Nuclear War** - \$29.95
- Nuclear Escalation** - \$29.95
- Nuclear Proliferation** - \$29.95
- Weapons of Mass Destruction** - \$19.95
- Deluxe population deck** - \$10
- Rare UFO Technology Card** - \$3
- Rare 200 Megaton Warhead Card** - \$3

Flying Buffalo Inc.

PO Box 8467, Scottsdale, AZ 85252
www.flyingbuffalo.com
games@flyingbuffalo.com

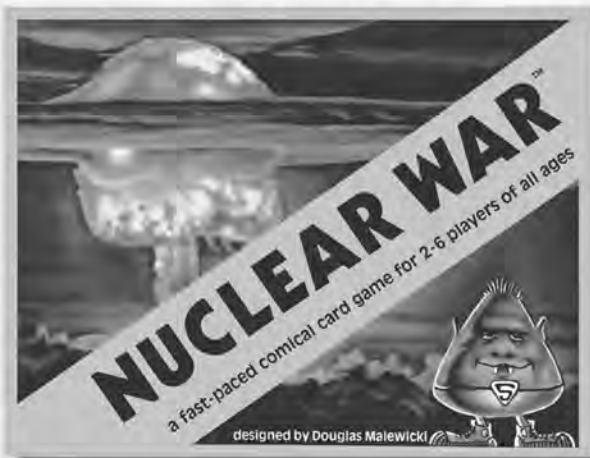

STARWEB - Try it for FREE!

The Play-by-mail
game of star-
spanning
empires!

Have you ever played the Award-winning Starweb play-by-mail game? Have you ever wondered what it was like? This is a multi-player, hidden movement, strategic space game for 15 players from all over the world. Moves are done once every two weeks, and can be submitted by email, fax, phone, or postal mail. You can find the rules online at www.flyingbuffalo.com/swrules.htm

We have arranged to allow you to try the game out for FREE. Just write or email us and ask to be in a STARWEB TRIAL GAME. It will be a limited size map, with only 6 players, and only run for 12 turns. But there is no cost to you. And one of the players will be designated the "mentor" to offer help whenever you have a question.

Flying Buffalo Inc. - fine games since 1970
 PO Box 8467, Scottsdale, AZ 85252
www.flyingbuffalo.com - games@flyingbuffalo.com





The Diceless Combat System

These books are a DICELESS fantasy combat system. Each player has a book, and you play by giving your book to your opponent, who reciprocates. You each pick a maneuver from your list of options, and tell the other player a page number. You each turn to the specified page number, and see what the other person is doing. For instance, you may choose to lunge at me, while I choose a side swing. When I turn to your page, I see you lunging at me, and when you turn to my page, you see yourself getting a hit on me. After I take a specified number of hits, I have lost the combat. It's very easy (the complete rules are included on each book) and very quick. You need any two books to play.

Lost Worlds Combat Books -

- Amara Wintersword - \$8.95
- Meresin, Dwarf with warhammer - \$8.95
- Mischa Redblur, Ultra Sorceress - \$8.95
- Umslopagaas of the shiny teeth - \$5.95
- Flaming Cherry with falchion and shield - \$5.95
- Kharis, the Royal Mummy with mace - \$5.95
- Chiron, Centaur Guard with short axe & shield - \$5.95
- MacAber, Highland Warrior with Claymore - \$5.95
- KODT* Bob (Knuckles) - \$8.95
- KODT* Dave (El Ravager) - \$8.95
- KODT* Brian (Teflon Billy) - \$8.95
- KODT* Sara (Thorina) - \$8.95

CHESSEX Lost Worlds Books

- Brimstone: Fire Giant - \$5.95
- Sir Percival: Mounted Knight - \$5.95
- Other: Djinn of Distinction - \$5.95

Lost Worlds Fantasy Cards

- Set A: Red Spells & Items (18 cards) - \$5
- Set B: Luck Cards & Weapons (18 cards) - \$5
- Set C: More Luck Cards & Weapons (17 cards) - \$5
- Set D: Purple Spells & Tactics (17 cards) - \$5
- Set E: 6 Yellow Spells & 7 Red Spells (13 cards) **SOLD OUT**
- Set F: 7 Amara Wintersword cards & 6 other cards not in the above sets \$5

Combat books previously published by Nova Games / Greysea

- Man w/short sword & dagger - \$5.95
- Woman in scale with sword & shield \$7.50
- Halfling w/sword & shield - \$7.50
- Woman w/quarterstaff - \$5.95
- Arafael the Angel - \$7.50
- Arcanthus the sage - \$7.50
- Bith, Female Mage - \$4
- Cal, Fighter Hero - \$4
- Cold Drake (dragon) - \$7.50
- Eilee the Sprite - \$7.50
- Endril, Elf Bowman - \$4
- Felina, Tiger Lady - \$7.50
- Hathor, Troll - \$4
- Manticore - \$5.95
- Man in Chainmail - \$5.95
- Skeleton - \$5.9
- Unicorn - \$7.50
- Winged Gargoyle - \$5.95
- Wraith - \$7.50

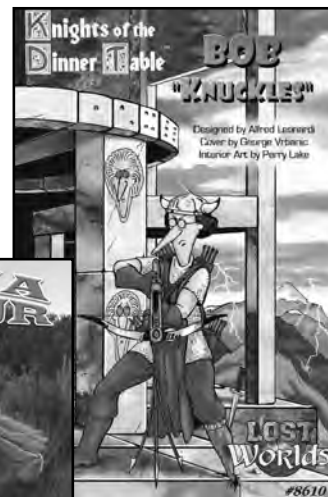

* "Knights of the Dinner Table", "KODT", Bob, Dave, Brian, Sara, Knuckles, El Ravager, Teflon Billy, & Thorina are trademarks of Kenzer & Co and are used with permission. All rights are reserved.

Ask for them at your local gamestore or go to www.flyingbuffalo.com or mail a check to:

Flying Buffalo - PO Box 8467, Scottsdale, AZ 85252, USA

Add \$3 postage for USA orders, \$8 postage for other countries.

**All of these books are compatible with each other -
So get a few and start fighting with your friends!**

DELUXE TUNNELS & TROLLS



- Updated Rules
- By Ken St Andre
- Talents
- New Races
- Expanded Magic
- Enhanced Humans
- More Weapons

- TrollWorld Section
- World Maps
- New Danforth Art
- Upgraded graphics
- New GM Adventure
- New Solo Adventure
- And more!



Watch for DELUXE
TUNNELS & TROLLS
coming this summer!

Get the
latest T&T
news at [www.
Trollhalla.com](http://www.Trollhalla.com)

AWARD WINNING BOOKS FOR ANY RPG!

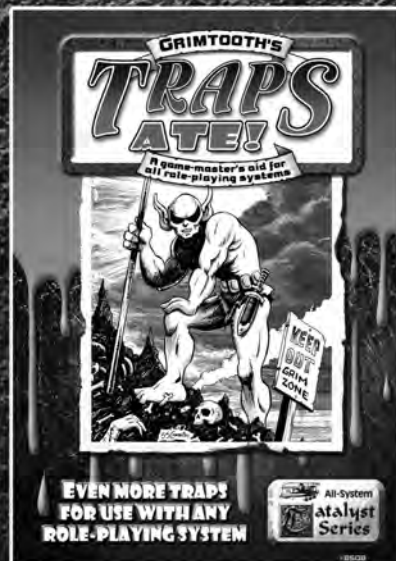
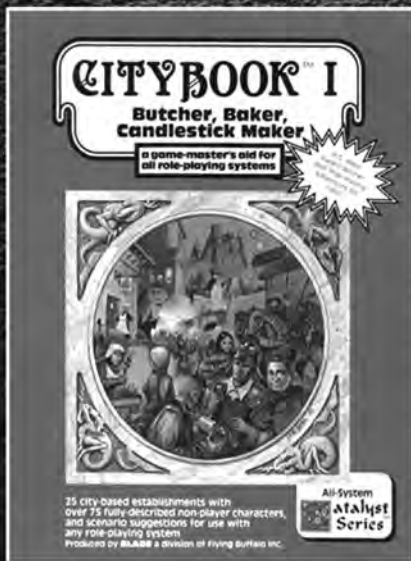

Ask for them at your local gamestore, or go to www.flyingbuffalo.com
Or write for our Free catalog:
Flying Buffalo, PO Box 8467, Scottsdale, AZ 85252

GRIMTOOTH'S TRAPS TOO

A game-master's aid for all role-playing systems



PLUS BRAND NEW GRIMTOOTH COMIC!



FOR ALL ROLE-PLAYING SYSTEMS

This book is a connoisseur's catalog of condemnable calamities, ghastly glammers, distinctive disasters, and an astonishing array of annoying misdirections and miserable misfortunes. . .

IN OTHER WORDS, THE TROLL IS BACK!

The 102 traps within this book have been presented without game mechanics of any kind; the nature, cause and effect of each trap has been thoroughly described so that any game master may introduce these devices of delver destruction into his or her campaign easily.

For example, **The Wet Pit**. This is a simple pit which



opens beneath the feet of a delver. As soon as the delver is trapped inside the pit, it begins to fill with water, bars spring across the top, and the walls begin to creep together.

However, just before the delver is drowned and pulped, the trap resets itself - the water drains out, the walls return their original positions, and the bars withdraw. A handy ladder then pops out of the pit wall, but suddenly. . . (continued on page 20)

Included in this new edition are 9 pages of material provided by the talented folks at Grey Ghost Press, Inc., which explain how to use all these traps in the "Fudge" system. Fudge is a customizable role-playing game, perfect for game masters who like to tinker with rules, and one of the many systems for which these traps are singularly appropriate!



ISBN 0-940244-78-0



7 24903 08502 4



Flying Buffalo Inc.
www.flyingbuffalo.com
ISBN 0-940244-78-0

#8502